

SAMSUNG

SAMSUNG

DLPTV

DLPTV



1-800-SAMSUNG (1-800-726-7864)

**Samsung Electronics America
Service Division**

400 Valley Road, Suite 201
Mount Arlington, NJ 07856
www.samsungusa.com

**Samsung Electronics Canada Inc.
Samsung Customer Care**

7037 Financial Drive
Mississauga, Ontario
L5N 6R3
www.samsung.ca

BP68-00188A-00

I N S T R U C T I O N M A N U A L

HLN467W1/HLN567W1/HLN4365W1/HLN5065W1/HLN437W1
HLN507W1/HLN617W1

Safety Instructions



Warning! Important Safety Instructions

CAUTION

RISK OF ELECTRIC SHOCK
DO NOT OPEN

CAUTION: TO REDUCE THE RISK OF ELECTRIC SHOCK, DO NOT REMOVE COVER (OR BACK). THERE ARE NO USER SERVICEABLE PARTS INSIDE. REFER ALL SERVICING TO QUALIFIED SERVICE PERSONNEL.

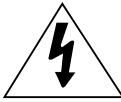

This symbol indicates high voltage is present. It is dangerous to make any kind of contact with any part inside this product.



This symbol alerts you that important literature concerning operation and maintenance has been included with this product.

CAUTION: FCC/CSA regulations state that any unauthorized changes or modifications to this equipment may void the user's authority to operate it.

CAUTION: To prevent electric shock, match the wide blade of plug to the wide slot, and fully insert the plug.

ATTENTION: Pour éviter les chocs électriques, introduire la lame la plus large de la fiche dans la borne correspondante de la prise et pousser jusqu'au fond.

Note to CATV system installer: This reminder is provided to call CATV system installer's attention to Article 820-40 of the National Electrical Code (Section 54 of Canadian Electrical Code, Part I), that provides guidelines for proper grounding and, in particular, specifies that the cable ground shall be connected to the grounding system of the building as close to the point of cable entry as possible.

Important: One Federal Court has held that unauthorized recording of copyrighted TV programs is an infringement of U.S. copyright laws. Certain Canadian programs may also be copyrighted and any unauthorized recording in whole or in part may be in violation of these laws.

**To prevent damage which may result in fire or electric shock,
do not expose this appliance to rain or moisture.**

Thank You for Choosing Samsung

Thank you for choosing Samsung! Your new Samsung projection TV represents the latest in Digital Light Processing television technology. We designed it with easy-to-use on-screen menus and closed captioning capabilities, making it one of the best products in its class. We are proud to offer you a product that will provide convenient, dependable service and enjoyment for years to come.

Important Safety Information

Always be careful when using your TV. To reduce the risk of fire, electrical shock, and other injuries, keep these safety precautions in mind when installing, using, and maintaining your unit.



- Read all safety and operating instructions before operating your TV.
- Keep the safety and operating instructions for future reference.
- Heed all warnings on the TV and in the operating instructions.
- Unplug the TV from the wall outlet before cleaning. Use a damp cloth; do not use liquid or aerosol cleaners.
- Never add any attachments and/or equipment without approval of the manufacturer. Such additions can increase the risk of fire, electric shock, or other personal injury.
- Do not use the TV where contact with water is possible, such as near bath tubs, sinks, washing machines, swimming pools, etc.
- Do not place the TV on an unstable cart, stand, tripod, bracket, or table where it can fall. A falling TV can cause serious injury to a child or adult, and serious damage to the appliance. Use only with a cart, stand, tripod, bracket, or table recommended by the manufacturer or sold with the TV. Follow the manufacturer's instructions when mounting the unit, and use a mounting accessory recommended by the manufacturer. Move the TV and cart with care. Quick stops, excessive force, and uneven surfaces can make the unit and cart unsteady and more likely to overturn.
- The TV is designed with slots in the cabinet for ventilation to protect it from overheating. Do not block these openings with any object, and do not put the TV on a bed, sofa, rug, or other similar surface. Do not put the TV near a radiator or heat register. If you do put the TV on a rack or bookcase, make sure that there is adequate ventilation and that you've followed the manufacturer's instructions for mounting.
- Operate your TV only from the type of power source indicated on the marking label. If you are not sure of the type of power supplied to your home, consult your appliance dealer or local power company.
- Use only a grounded or polarized outlet. For your safety, this TV is equipped with a polarized alternating current line plug having one blade wider than the other. This plug will fit into the power outlet only one way. If you are unable to insert the plug fully into the outlet, try reversing the plug. If the plug still does not fit, contact an electrician to replace your outlet.



Safety Instructions

- Protect the power cord. Power supply cords should be routed so that they won't be walked on or pinched by objects placed on or against them. Pay particular attention to cords at plugs, convenience receptacles, and the point where they exit from the unit.
- Unplug the TV from the wall outlet and disconnect the antenna or cable system during a lightning storm or when left unattended and unused for long periods of time. This will prevent damage to the unit from lightning and power-line surges.
- Avoid overhead power lines. An outside antenna system should not be placed in the vicinity of overhead power lines or other electric light or power circuits, or where it can fall into such power lines or circuits. When installing an outside antenna system, be extremely careful to keep from touching the power lines or circuits. Contact with such lines can be fatal.
- Do not overload the wall outlet or extension cords. Overloading can result in fire or electric shock.
- Do not insert anything through the openings in the unit, where they can touch dangerous voltage points or damage parts. Never spill liquid of any kind on the TV.
- Ground outdoor antennas. If an outside antenna or cable system is connected to the TV, be sure the antenna or cable system is grounded so as to provide some protection against voltage surges and built up static charges. Section 810 of the National Electrical Code, ANSI/NFPA No.70-1984, provides information about proper grounding of the mast and supporting structure, grounding of the lead-in wire to an antenna discharge unit, size of grounding conductors, location of antenna discharge unit, connection to grounding electrodes, and requirements for the grounding electrode.
- Do not attempt to service the TV yourself. Refer all servicing to qualified service personnel. Unplug the unit from the wall outlet and refer servicing to qualified service personnel when:
 - The power-supply cord or plug is damaged
 - Liquid has been spilled on the unit or if objects have fallen into the unit
 - The TV has been exposed to rain or water
 - The TV does not operate normally by following the operating instructions
 - The TV has been dropped or the cabinet has been damaged
 - The TV exhibits a distinct degradation in performance
 - When the LAMP(BULB ONLY) replacement procedure on pg. 11 is unsuccessful
- If you make adjustments yourself, adjust only those controls that are covered by the operating instructions. Adjusting other controls may result in damage and will often require extensive work by a qualified technician to restore the TV to normal.
- When replacement parts are required, be sure the service technician uses replacement parts specified by the manufacturer or those that have the same characteristics as the original part. Unauthorized substitutions may result in additional damage to the unit.
- Upon completion of any service or repairs to this TV, ask the service technician to perform safety checks to determine that the TV is in a safe operating condition.

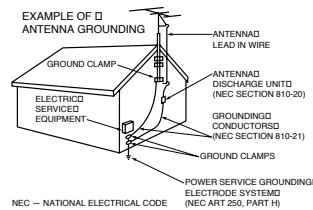

FCC Information

User Instructions

The Federal Communications Commission Radio Frequency Interference Statement includes the following warning:

NOTE: This equipment has been tested and found to comply with the limits for a Class B digital device, pursuant to Part 15 of the FCC Rules. These limits are designed to provide reasonable protection against harmful interference in a residential installation. This equipment generates, uses, and can radiate radio frequency energy and, if not installed and used in accordance with the instructions, may cause harmful interference to radio communications. However, there is no guarantee that interference will not occur in a particular installation.

If this equipment does cause harmful interference to radio or television receptions, which can be determined by turning the equipment off and on, the user is encouraged to try to correct the interference by one or more of the following measures:

- Reorient or relocate the receiving antenna.
- Increase the separation between the equipment and receiver.
- Connect the equipment into an outlet on a circuit different from that to which the receiver is connected.
- Consult the dealer or an experienced radio/TV technician for help.

User Information

Changes or modifications not expressly approved by the party responsible for compliance could void the user's authority to operate the equipment. If necessary, consult your dealer or an experienced radio/television technician for additional suggestions. You may find the booklet called How to Identify and Resolve Radio/TV Interference Problems helpful. This booklet was prepared by the Federal Communications Commission. It is available from the U.S. Government Printing Office, Washington, DC 20402, Stock Number 004-000-00345-4.

The party responsible for product compliance:
SAMSUNG ELECTRONICS CO., LTD
America QA Lab of Samsung
3351 Michelson Drive,
Suite #290, Irvine, CA92612 USA

Warning

User must use shielded signal interface cables to maintain FCC compliance for the product. Provided with this monitor is a detachable power supply cord with IEC320 style terminations. It may be suitable for connection to any UL Listed personal computer with similar configuration. Before making the connection, make sure the voltage rating of the computer convenience outlet is the same as the monitor and that the ampere rating of the computer convenience outlet is equal to or exceeds the monitor voltage rating. For 120 Volt applications, use only UL Listed detachable power cord with NEMA configuration 5-15P type (parallel blades) plug cap. For 240 Volt applications use only UL Listed Detachable power supply cord with NEMA configuration 6015P type (tandem blades) plug cap.

IC Compliance Notice

This Class B digital apparatus meets all requirements of the Canadian Interference-Causing Equipment Regulations.

Notice de Conformité IC

Cet appareil numérique de classe B respecte toutes les exigences du Règlement sur les équipements produisant des interférences au Canada.

This Class B digital apparatus complies with Canadian ICES-003.

Cet appareil numérique de la classe B est conforme à la norme NMB-003 du Canada.

This device complies with part 15 of the FCC Rules. Operation is subject to the following two conditions:

- (1) This device may not cause harmful interference, and
- (2) This device must accept any interference received, including interference that may cause undesired operation.

This television receiver provides display of television closed captioning in accordance with §15.119 of the FCC rules.

Table of Contents

Your New Wide TV	10
Replacing the Lamp	10
List of Features	12
Checking Parts	12
Side Panel Buttons	13
Side Panel Jacks	13
Front Panel LED Indicators	14
Rear Panel Jacks	15
Remote Control	16
Installing Batteries in the Remote Control	17
Connections	20
Connecting VHF and UHF Antennas	20
Antennas with 300-ohm Flat Twin Leads	20
Antennas with 75-ohm Round Leads	20
Separate VHF and UHF Antennas	21
Connecting Cable TV and VCR	22
Cable without a Cable Box	22
Cable with a Cable Box that Descrambles All Channels	22
Connecting a Cable Converter Box	23
Connecting a Cable Converter Box and a VCR	23
Connecting a Camcorder	24
Connecting a DVD Player	25
Connecting to Y,PB,PR	25
Connecting to audio and video jacks	25
Connecting a DTV Set Top Box	26
Connecting to Y,PB,PR	26
Connecting to DVI (Digital Visual Interface)	26
Connecting to R,G,B	27
Operation	30
Turning the TV On and Off	30
Viewing the Menus and Displays	30
Selecting the Menu Language	31
Selecting the Antenna Input	31
Channel Memory	33
Changing Channels	34
Selecting Your Favorite Channels	35
Scanning Channels	36
Labeling the Channels	37
Picture Control	38
Sound Control	40
Setting the Clock	42
Setting the Timers	43
Viewing an External Signal Source	46

Special Features	50
Setting Up Your Remote Control	50
Remote Control Codes	53
Fine Tuning Channels	54
LNA (Low Noise Amplifier)	55
Selecting the Color Tone	56
Setting the Film Mode	56
DNIe™ (Digital Natural Image engine) DNIe™ 	57
Digital Noise Reduction	58
Setting the Blue Screen Mode	59
Changing the Screen Size	60
Special Audio Options	61
MTS Settings: Choosing a Soundtrack	61
Virtual Dolby	62
BBE	63
Auto Volume	64
Setting The On/Off Melody	65
Viewing Closed Caption Information	66
Viewing Picture-in-Picture	67
Selecting a PIP Screen	67
Selecting an External Signal	68
Selecting a Signal Source (Antenna or Cable) for PIP	69
Swapping the Contents of the PIP and Main image	70
Changing the Size of the PIP image	71
Changing the Location of the PIP Image	72
Changing the Picture-in-Picture Channel	73
Selecting the Sound Source	74
Using the V-Chip	75
PC Display	82
Using Your TV as a Computer (PC) Display	82
How to connect Your PC to the TV	82
How to Set up Your PC Software (Windows only)	83
Display Modes	84
How to Set up Your TV as a PC display	85
Picture Quality Adjustment	86
Changing the Position of the Image (Moving left, right, up and down)	88
Changing the Screen Size (PC mode)	90
Appendix	94
Troubleshooting	94
Care and Maintenance	95
Using Your TV in Another Country	95
Specifications	95

SAMSUNG

Your New Wide TV

Your New Wide TV

Replacing the Lamp

- **Why do I need to replace the lamp?**

The lamp used in a projection TV has a limited lifespan. For the best screen quality it needs to be replaced periodically.

After replacing the lamp, the screen quality will be bright and clear as new.

- **When do I need to replace it?**

It should be replaced when the screen becomes darker, less clear or when all three LEDs on the front (Timer, Lamp, & Temp.) are flashing.

- **Check before lamp replacement**

1. The lamp must be the same code number and type.
2. The lamp type is indicated on the right side of the TV. It is also indicated on the lamp case.
3. After checking the code number for the lamp, give the code number to the store where you purchased the TV or to a Samsung Service center.

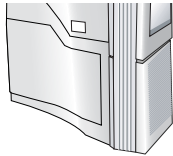

▲ HLN437W1/HLN507W1
HLN617W1/HLN4365W1
HLN5065W1

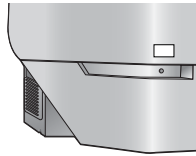

▲ HLN467W1/HLN567W1

- **Caution**

1. Replace with the correct code numbered lamp to avoid damage to the TV.
2. Turn the power off and wait for 30 minutes before replacing the lamp as it will be hot.
3. Do not touch the glass part of the lamp with your bare hands nor insert any foreign object inside the cover as it may cause poor screen quality, electric shock or fire.
4. Do not place the old lamp near flammable objects or within the reach of children.

• For replacement, you will need a 5.91 Inches-long Phillips screwdriver and a pair of gloves.

- 1 Unplug TV, then use a screwdriver to remove the screw as shown in the picture.
(HLN467W1/HLN567W1: Remove the rubber cap and unscrew the screw.)

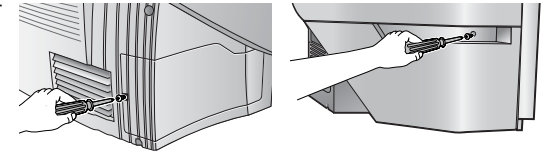

- 2 Remove the Lamp cover.
(HLN467W1/HLN567W1: Exert a bit of force to the right and pull for easy opening.)

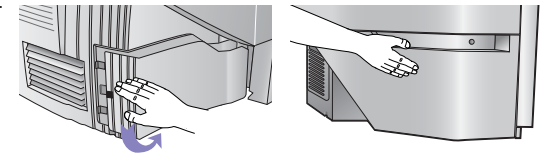

- 3 Use a screwdriver to remove the screws securing the Lamp. There are 2 screws: one on the left and one on the right. When the screws have been completely unfastened, they will still be connected to the body of the Lamp.

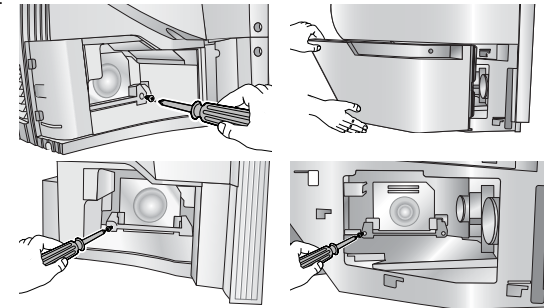

- 4 Separate the Lamp from the engine by holding the handle and pulling it out.

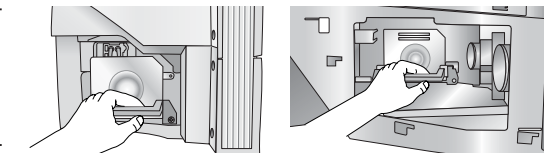

- 5 To reinstall the Lamp, follow these steps in reverse order.

▲ HLN437W1/HLN507W1
HLN617W1/HLN4365W1
HLN5065W1

▲ HLN467W1/HLN567W1

NOTES

- Be sure the replacement Lamp is the same type.
- After replacing the lamp, align the lamp cover with the groove and secure the screw.
- The TV will not turn on if the lamp cover is not correctly closed (as this will activate the protective circuit).

Your New Wide TV

List of Features

Your TV was designed and engineered using the latest technology. It is a full-featured, high-performance unit that exceeds industry standards. In addition, it has these special features:

- Easy-to-operate remote control
- Easy-to-use on-screen menu system you can access from the side panel or remote control
- Automatic timer to turn the TV on and off at any time you choose
- Adjustable picture and sound settings and the ability to memorize your favorite settings
- Automatic channel tuning for up to 181 channels
- A special filter to reduce or eliminate reception problems
- Fine tuning control for the sharpest picture possible
- A built-in multi-channel sound decoder for stereo and bilingual listening
- Built-in, dual channel speakers
- A special sleep timer
- Picture-in-Picture capability that lets you watch two channels at once
- Widescreen TV with adjustable image size
- Life-like clear images provided by DNLe technology

Checking Parts

Once you have unpacked your TV, check to make sure that you have all the parts shown here. If any piece is missing or broken, call your dealer.

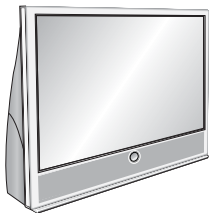

Television



Remote Control
(BP59-00048A)/
AAA Batteries
(4301-000121)



This Manual



Warranty Card

Side Panel Buttons

The buttons on the side panel control your TV's basic features, including the on-screen menu system. To use the more advanced features, you must use the remote control.

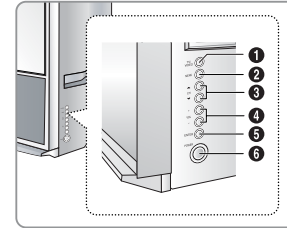

◀ HLN467W1
◀ HLN567W1

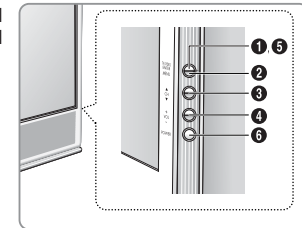

◀ HLN437W1
◀ HLN507W1
◀ HLN4365W1
◀ HLN5065W1

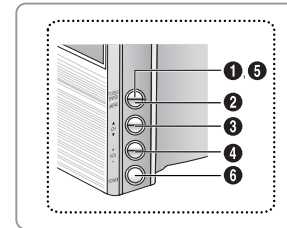

◀ HLN617W1

1 TV/VIDEO

Press to switch between viewing TV programs and signals from connected components.

2 MENU

Press to see the on-screen menu.

3 ▼ CH ▲

Press to change channels and move between items on the on-screen menu.

4 VOL +, -

Press to lower or raise the volume and to select items when using the on-screen menu.

5 ENTER

Press to activate (or change) a particular item.

6 POWER

Press to turn the TV on and off.

Side Panel Jacks

Use the side panel jacks to connect a component that is used only occasionally (a camcorder or video game, for example).

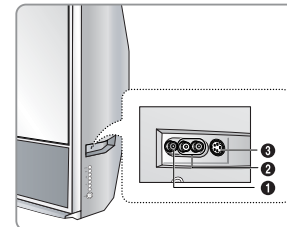

◀ HLN467W1
◀ HLN567W1

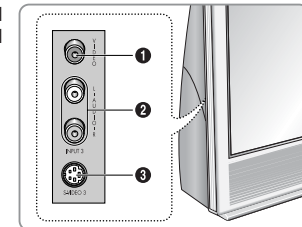

◀ HLN437W1
◀ HLN4365W1

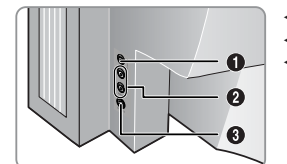

◀ HLN507W1
◀ HLN617W1
◀ HLN5065W1

1 VIDEO Input jack

Connect the video signal from a camcorder or video game.

2 AUDIO Input jacks

Connect the audio signal from a camcorder or video game.

3 S-VIDEO Input jack

Connect an S-video signal from a camcorder or video game. (S-Video 3 jack and Audio L/R input 3 are used in conjunction.)

Your New Wide TV

Front Panel LED Indicators

The three lights on the front panel indicate the status of your TV.

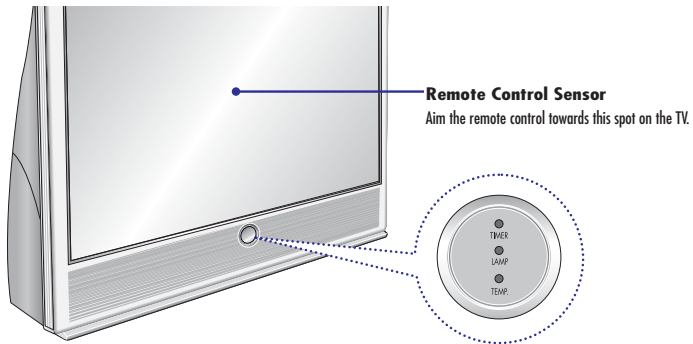

- : Light is On
- ◐ : Light is Blinking
- : Light is Off

Timer	Lamp	Temp	Indication
●	○	○	Auto Timer ON/OFF has been set.
○	◐	○	Standby state. The picture will automatically appear in about 25 seconds.
●	◐	○	Auto Timer ON/OFF has been set and the set will automatically be turned on in about 25 seconds.
◐	○	◐	A cooling fan inside the set is not operating normally.
○	◐	◐	Lamp cover on rear of the set is not properly shut.
○	○	◐	Check if the ventilation hole on the rear of the set is blocked, because if the inner temperature is too high, the power will shut off.
◐	◐	◐	Lamp may be defective. Please contact a certified technician.

- It takes about 30 seconds for the TV to warm up, so normal brightness may not appear immediately.
- The TV has a fan to keep the inside lamp from overheating. You'll occasionally hear it working.

Rear Panel Jacks

Use the rear panel jacks to connect components such as a VCR. You can connect different components such as VCRs, Set-Top Box and a DVD player etc., because there are two sets of video input jacks and three set of component video input jacks on the rear panel of your TV. For more information, please see "Connections".

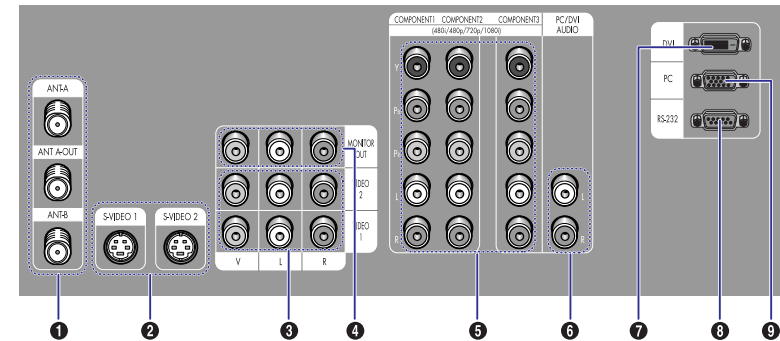

1 ANTENNA terminals

Two independent cables or antennas can be connected to these terminals. Use ANT-A and ANT-B terminals to receive a signal from VHF/UHF antennas or your cable system. Use the ANT-A-OUT terminal to send the signal being received by the ANT-A terminal out to another component (such as a Cable Set Top Box). The PIP channel can be received only when a signal source is connected to ANT-A.

2 S-VIDEO INPUT jacks

Connects an S-Video signal from an S-VHS VCR or DVD player.

3 VIDEO/AUDIO INPUT jacks(VCR1, VCR2)

Connect video/audio signals from external sources, such as a VCR or DVD players.

4 VIDEO/AUDIO MONITOR OUTPUT jacks

Sends a video signal from the TV to an external source, such as a VCR.

Note: Monitor Out is available only in RF, Video and S-Video modes.

5 Component 1, 2, 3 jacks (Y, Pb, Pr, L, R)

Use these jacks to connect the component video/audio signals from a DVD player or a set top box when using the component video input jacks.

6 PC/DVI AUDIO INPUT jacks

Connect these to the audio-output jacks on your PC or set top box.

7 DVI (Digital Video Interface) jack

Receives the digital signals from a set top box or PC etc.

8 RS-232 jack

The RS232 jack is for repair and software upgrades.

9 PC VIDEO INPUT jack

Connect to the video output port on your PC.

Your New Wide TV

Remote Control

You can use the remote control up to a distance of about 23 feet from the TV. When using the remote, always point it directly at the TV. The remote control can also operate your Set Top Box, VCR, cable box, and DVD player.

- 1. POWER**
Turns the TV on and off.
- 2. S.MODE**
Adjust the TV sound by selecting one of the preset factory settings (or select your personal, customized sound settings.)
- 3. P.MODE**
Adjust the TV picture by selecting one of the preset factory settings (or select your personal, customized picture settings.)
- 4. +100**
Press to select cable channels over 100 on TV.
- 5. VOL -, VOL +**
Press to increase or decrease the volume.
- 6. MUTE**
Press to mute the TV sound.
- 7. FAV.CH (Favorite Channel)**
Press to switch between your favorite channels.
- 8. MENU**
Displays the main on-screen menu.
- 9. STILL**
Press to stop the action during a particular scene. Press again to resume normal video.
- 10. P.SIZE**
Press to change the screen size.
- 11. MODE**
Selects a target device to be controlled by the Samsung remote control (i.e., TV, VCR, Cable, or DVD).
- 12. PRE-CH**
Tunes to the previous channel.
- 13. TV/VIDEO**
Press to display all of the available video sources (i.e., TV, STB, VCR, DVD, DTV, PC).
- 14. CH ^ and CH v (Channel Up/Down)**
Press CH ^ or CH v to change channels.
- 15. INFO**
Press to display information on the TV screen.
- 16. EXIT**
Press to exit the menu.
- 17. UP, Down, Left, Right (▲, ▼, ◀, ▶)/ENTER**
Press to select highlight up, down, left, or right. While using the on-screen menus, press ENTER to activate (or change) a particular item.
- 18. MTS (Multichannel Television Stereo)**
Press to choose stereo, mono or Separate Audio Program (SAP broadcast).
- 19. SURROUND**
Press to hear the Dolby surround effect.
- 20. ADD/DEL**
Press to add or erase channels in the TV's memory. Use the ADD/DEL button to memorize/erase the fine tuning after fine tuning channels.
- 21. SLEEP**
Press to select a preset time interval for automatic shutoff.
- 22. PIP**
Activates picture in picture.
- 23. SET**
Used during set up of this remote control, so that it will work compatibly with other devices (VCR, STB, cable box, DVD, etc.)
- 24. DNLe**
Activates DNLe (Digital Natural Image engine).
- 25. PIP controls**
SWAP; Exchanges the video signal that is currently displayed on the main screen with the signal in the PIP window.
SIZE: Press to make the PIP window larger or smaller.
CH (PIP); Displays the available channels in sequence. (These buttons change channels in the PIP window only.)
- 26. VCR controls**
Controls VCR tape functions: Rewind, Play, Fast Forward, Stop, Pause.
- 27. RESET**
If your remote control is not functioning properly, take out the batteries and press the reset button for about 2-3 seconds. Re-insert the batteries and try using the remote control again.

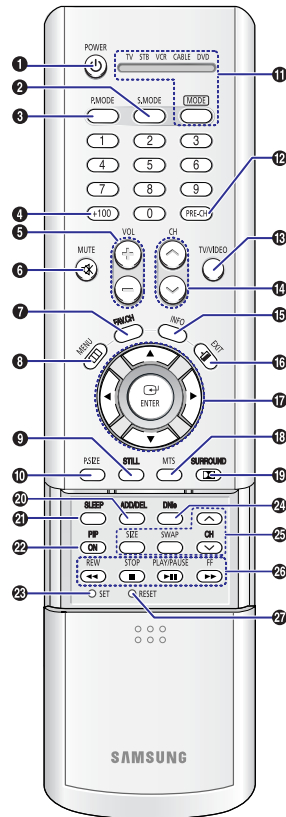

Installing Batteries in the Remote Control

With normal use, the batteries in the remote control should last about a year. If you notice a performance degradation while using the remote, the batteries may need to be replaced. Make sure you replace both batteries and do not mix old and new batteries in the remote control. If you won't be using the remote control for a long time, remove the batteries and store them in a cool dry place.

- 1** Slide the back cover all the way out to open the battery compartment of the remote control.

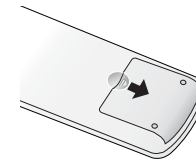

- 2** Install two AAA size batteries. Make sure to match the "+" and "-" ends of the batteries with the diagram inside the compartment.

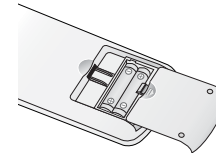

- 3** Slide the cover back into place.

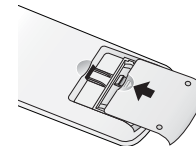

Connections

SAMSUNG

Connections

Connecting VHF and UHF Antennas

If you do not have a cable system, you will need to connect an antenna to your TV.

Antennas with 300-ohm Flat Twin Leads

If your antenna looks like this:  it has 300-ohm flat twin leads.

- 1 Place the wires from the twin leads under the screws on the 300-75 ohm adapter. Use a screwdriver to tighten the screws.

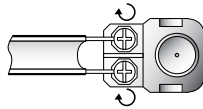

- 2 Plug the adapter into the ANT-A terminal on the back panel of the TV.

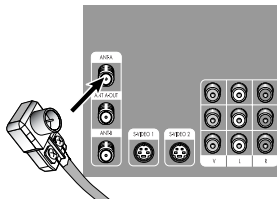

Antennas with 75-ohm Round Leads

If your antenna looks like this:  it is an antenna with 75-ohm round leads.

- 1 Plug the antenna lead into the ANT-A terminal on the back panel of the TV.

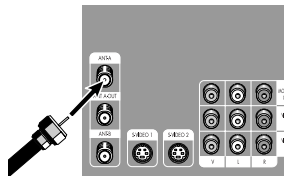

Separate VHF and UHF Antennas

If you have two separate antennas for your TV (one VHF and one UHF), you must combine the two antenna signals before connecting them to the TV. This requires a combiner attachment, which you can buy at an electronics store.

- 1 Connect both antenna leads to the combiner.

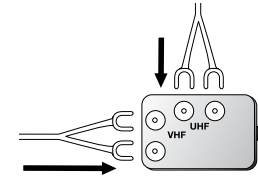

- 2 Plug the combiner into the ANT-A terminal on the back panel of the TV.

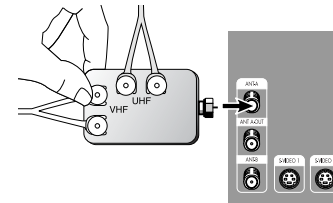

Connections

Connecting Cable TV and VCR

You can connect different cable systems to your TV, including cable without a cable box, and cable with a cable box that descrambles some or all channels.

Cable without a Cable Box

If you want to connect cable, and you do not need to use a cable box:

- 1 Plug the incoming cable into the ANT-A terminal on the back of the TV.

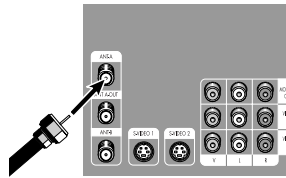

Cable with a Cable Box that Descrambles All Channels

- 1 Find the cable that is connected to the ANTENNA OUT terminal on your cable box. This terminal might be labeled "ANT OUT", "VHF OUT" or simply, "OUT".

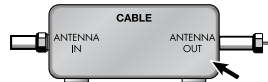

- 2 Connect the other end of this cable to the ANT-A terminal on the back of the TV.

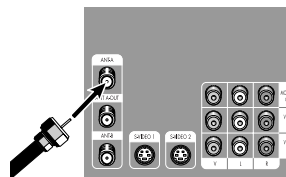

Connecting a Cable Converter Box

This connection allows you to watch cable and premium channels. You should keep your TV selected to ANT-A so that you can use the TV features. When viewing premium channels, select ANT-B and tune the TV to channel 3 or 4 (whichever channel is vacant in your area), then use the converter box to change channels. You will need two coaxial cables.

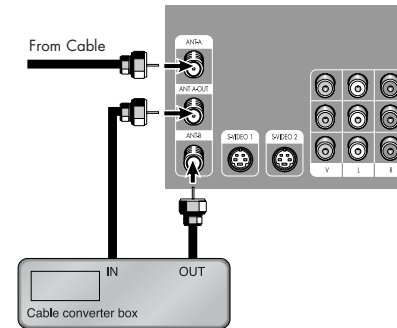

Note: When you use a converter box with your TV, there may be features that you can not program using the remote control, such as programming your favorite channels and blocking channels.

Connecting a Cable Converter Box and a VCR

This connection allows you to watch and record basic and premium cable channels, as well as watch videotapes. You should keep your TV selected to ANT-A so that you can use the TV's features. When viewing premium channels or recording with the VCR, select ANT-B (whichever channel is vacant in your area), then use the converter box to change channels.

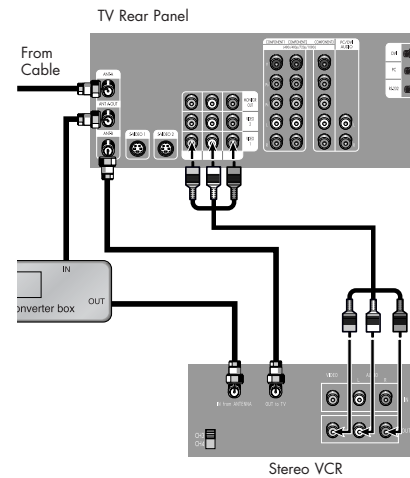

Caution: If you want to record one channel while watching another channel, a splitter (not included) must be added between the cable and ANT-A. One output of the splitter goes to ANT-A and the second output is connected to IN on the cable converter box.

If you have a mono VCR, connect L/Mono to VCR Audio OUT using only one audio cable.

If you have a S-VHS VCR, use the S-video connections and remove the video cable. Do not connect the video cable and the S-video cable to video1 simultaneously.

When you use a converter box with your TV there may be features that you can not program using the remote control, such as programming your favorite channels and blocking channels.

Connections

Connecting a Camcorder

The side panel jacks on your TV make it easy to connect a camcorder to your TV. You can use your camcorder to view tapes without using a VCR.

- 1 Locate the A/V output jacks on the camcorder. They are usually found on the side or back of the camcorder.

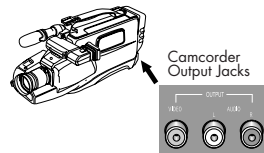

- 2 Connect an audio cable between the AUDIO OUTPUT jack on the camcorder and the AUDIO terminals on the side of the TV. If your camcorder is stereo, you must connect two separate cables. (The audio cables are usually included with the camcorder.)

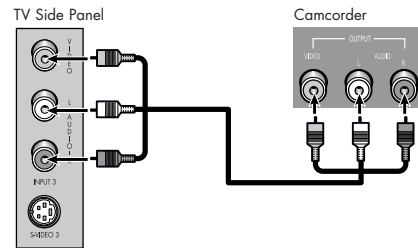

- 3 Connect a video cable between the VIDEO OUTPUT jack on the camcorder and the VIDEO terminal on the side of the TV. (A video cable is usually included with the camcorder.) To watch a tape, follow your camera's instructions and the section on "Viewing an External Signal Source" in this manual.

Connecting a DVD Player

The rear panel jacks on your TV make it easy to connect a DVD player to your TV.

Connecting to Y,Pb,Pr

- 1 Connect a set of audio cables between the Component (1, 2 or 3) AUDIO IN jacks on the TV and the AUDIO OUT jacks on the DVD player.

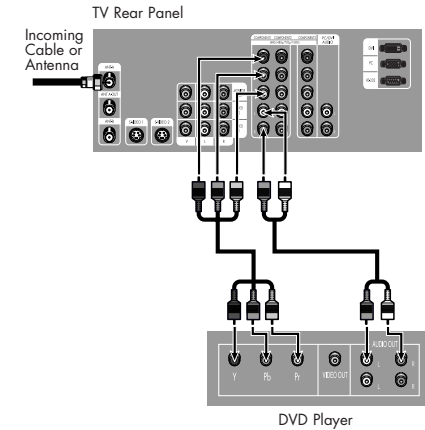

- 2 To enable Component video viewing, connect video cables between the Component (1, 2 or 3) Y, Pb and Pr jacks on the TV and Y, Pb and Pr (or Y, Cb, Cr) output jacks on the DVD player. Note: For an explanation of Component video, see your DVD player's owner's manual.

Connecting to audio and video jacks

- 1 Connect a set of audio cables between the AUDIO IN jacks on the TV and the AUDIO OUT jacks on the DVD player.
- 2 Connect video cables between the VIDEO OUT jack on the DVD player and the VIDEO IN jack on the TV.

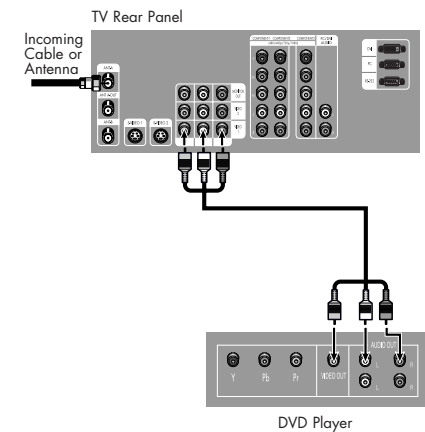

Connections

Connecting a DTV Set Top Box

Connecting to Y,Pb,Pr

- 1 Connect a set of audio cables between the Component (1, 2 or 3) AUDIO IN jacks on the TV and the AUDIO OUT jacks on the Set Top Box.
- 2 Connect video cables between the Component (1, 2 or 3) Y, Pb and Pr inputs on the TV and Y, Pb and Pr (or Y, Cb, Cr) outputs on the Set Top Box.
Note: For an explanation of Component video, see your Set Top Box owner's manual.

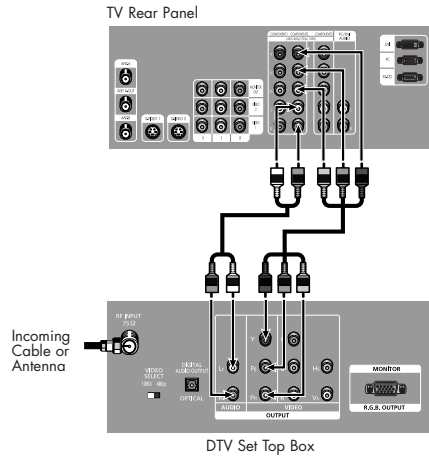

Connecting to DVI (Digital Visual Interface)

- 1 Connect a set of audio cables between the PC/DVI AUDIO IN jacks on the TV and the AUDIO OUT jacks on the Set Top Box.
- 2 Connect video cables between the DVI IN jack on the TV and the DVI OUT jack on the Set Top Box.

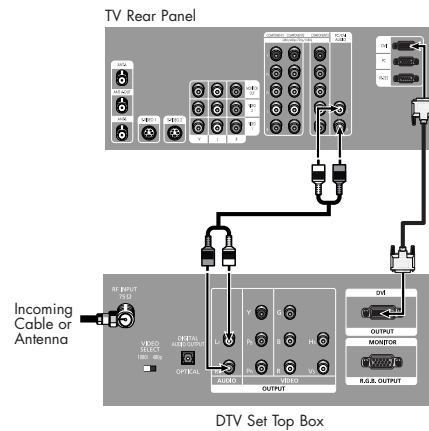

Connecting to R,G,B

- 1 Connect a set of audio cables between the PC/DVI AUDIO IN jacks on the TV and the AUDIO OUT jacks on the Set Top Box.
- 2 Connect video cables between the PC IN jack on the TV and the R.G.B OUT jack on the Set Top Box.

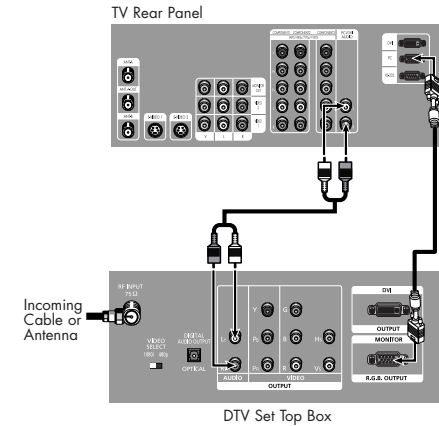

Operation

SAMSUNG

Operation

Turning the TV On and Off

Press the POWER button on the remote control or on the side panel to turn your TV on and off. Note that audio on this product can be working before screen video.

Viewing the Menus and Displays

The on-screen menu system allows you to control the settings of your TV. Access the on-screen menu system by pressing the MENU button on the remote control. Once the on-screen menu appears, use the ▲/▼/◀/▶/ENTER on your remote control to select menu items and make adjustments. You can also view the on-screen menu system and make some adjustments using the TV's side panel buttons.

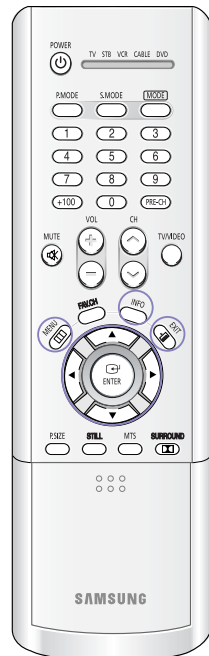

Displaying the Menus

1 With the power on, press the MENU button on the remote control. The main menu appears on the screen. The Input menu is selected.

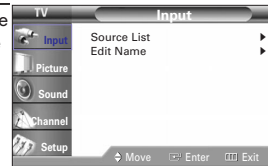

2 Use the ▲ or ▼ button to select to items in the menu. Use the ◀, ▶ or ENTER button to display, change, or use the selected items. Use the ENTER or ▶ button to enter items in the menu. On-screen menus disappear from the screen automatically after about two minutes, or you can press the EXIT button on your remote control to exit the menu.

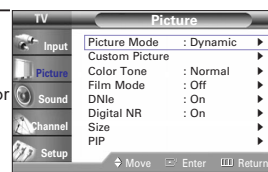

Displaying Status Information

1 Press the INFO button on the remote control. The TV will display the channel, current time, and the audio signal you are listening to.

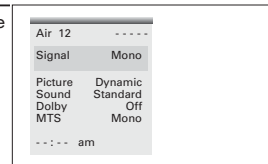

Selecting the Menu Language

Choose a language for the on-screen menus: English, Spanish or French.



1 Press the MENU button. Press the ▲ or ▼ button to select "Setup", then press the ENTER button.

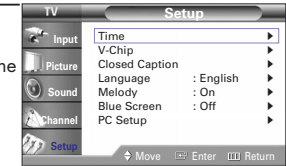

2 Press the ▲ or ▼ button to select "Language", then press the ENTER button.

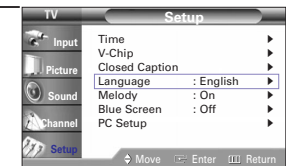

3 Press the ▲ or ▼ button to select the language, then press ENTER button. Press the EXIT button to exit the menu.

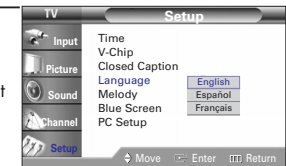

Selecting the Antenna Input

You can connect to two different signal sources by choosing the antenna input(A or B).

1 Press the MENU button. Press the ▲ or ▼ button to select "Channel", then press the ENTER button.

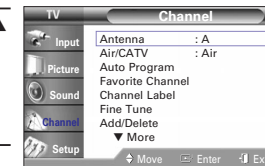

2 Press the ENTER button to select "Antenna".

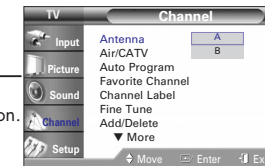

3 Press the ▲ or ▼ button to select "A" or "B", then press ENTER button. Press the EXIT button to exit the menu.

Operation

Channel Memory

Your TV can memorize and store all of the channels available. Once the channels are memorized, you can use the CH \wedge and CH \vee buttons to scan through the available channels.

Selecting the Broadcast Source

Before memorizing available channels, you must select what broadcast source your TV is connected to, either an antenna or a cable system.

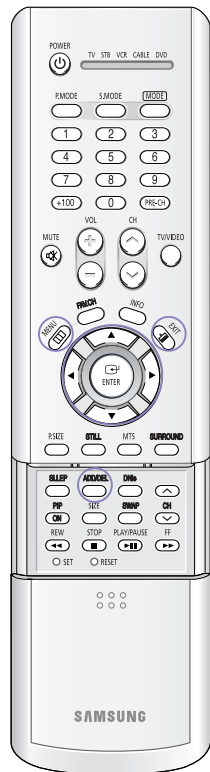

- 1 Press the MENU button. Press the \blacktriangle or \blacktriangledown button to select "Channel", then press the ENTER button.

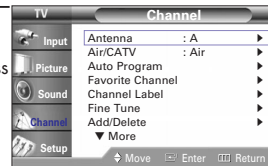

- 2 Press the \blacktriangle or \blacktriangledown button to select "Air/CATV", then press the ENTER button. If you are connected to an antenna, leave "Air" displayed. If you connected cable, press the \blacktriangle or \blacktriangledown button to select the type of cable system: "STD", "HRC" or "IRC". (If you are not sure which type of cable system you have, contact your cable company). Press the EXIT button to exit the menu.

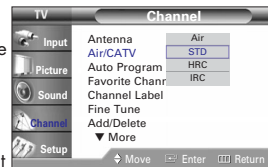
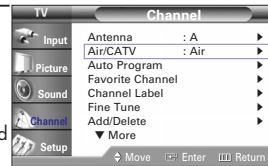

Storing Channels in Memory Automatically

- 1 First, select the broadcast source as described on the previous page. With the Channel menu on screen, press the \blacktriangle or \blacktriangledown button to select "Auto Program", then press the ENTER button.

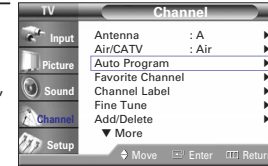

- 2 Press the ENTER button to select "Start". The TV will begin memorizing all of the available stations. Press the ENTER button at any time to interrupt the memorization process. Press the EXIT button to exit the menu.

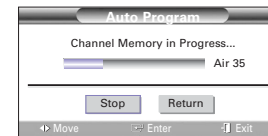
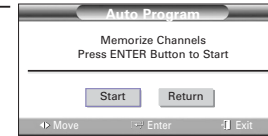

Adding and Erasing Channels

- 1 Press the MENU button. Press the \blacktriangle or \blacktriangledown button to select "Channel", then press the ENTER button. Quick way to access Add/Delete: Just press the ADD/DEL button on the remote control.

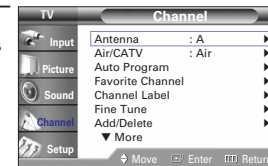

- 2 Press the \blacktriangle or \blacktriangledown button to select "Add/Delete", then press the ENTER button.

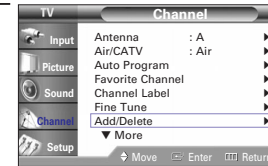

- 3 Press the CH \wedge / \vee or number buttons to select the channel you want to add or delete. Press the ENTER button to add or delete the channel. Press the EXIT button to exit the menu.



Operation

Changing Channels

You can change channels on your TV by using the CH \wedge and CH \vee buttons, or by direct selection using the number buttons. You can use the number buttons to tune to any channel (even one that has been erased or has not been memorized).



Using the Channel Buttons

Press the CH \wedge or CH \vee buttons to change channels. The TV changes each channel in order, up or down, depending on which button you press. You will see all the channels that the TV has memorized. (The TV must have memorized at least three channels.) You will not see channels that were not memorized or have been erased.

Using the Number Buttons

To change to single-digit channels (0–9) faster, press "0" before the single digit.

Example: For channel 4, press "0", then "4".

To select a channel over 100, press the +100 button first.

Example: For channel 122, press "+100", then "2", then "2".

Using the Previous Channel

Press the PRE-CH button on the remote control. The TV changes to the last channel you were watching.

Selecting Your Favorite Channels

You can store your favorite channels for each available input source (such as TV and CATV). Then, when you press the FAV.CH button on the remote control, the TV displays only the favorite channels you previously stored, allowing you to quickly and easily find frequently watched channels.



To Store Your Favorite Channels:

- 1 Press the MENU button. Press the \blacktriangle or \blacktriangledown button to select "Channel", then press the ENTER button.
- 2 Press the \blacktriangle or \blacktriangledown button to select "Air/CATV", then press the ENTER button. Press the \blacktriangle or \blacktriangledown button to select the type of cable system or Air, then press the ENTER button.
- 3 Press the \blacktriangle or \blacktriangledown button to select "Favorite Channel", then press the ENTER button.
- 4 Press the \blacktriangle or \blacktriangledown button. Press the \blacktriangle or \blacktriangledown button to select channel, then press the ENTER button. Press the EXIT button to exit the menu.

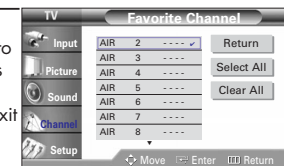
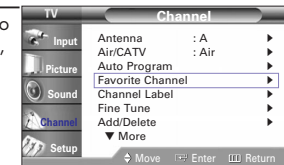
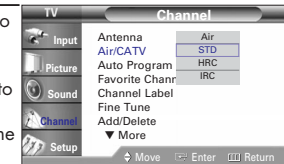
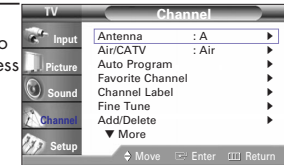

NOTE

- Only memorized channels can be set as Favorite channels.

To View Your Favorite Channels:

Press the FAV.CH button repeatedly to jump from one favorite channel to another. The favorite channels are selected in ascending sequence.

Operation

Picture Control

Using the remote, you can change the contrast, brightness, tint, color, and sharpness settings of the TV.



Customizing the Picture

1 Press the MENU button. Press the ▲ or ▼ button to select "Picture", then press the ENTER button.

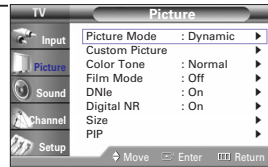

2 Press the ▲ or ▼ button to select "Custom Picture", then press the ENTER button. You will see the items "Contrast", "Brightness", "Sharpness", "Color" or "Tint".

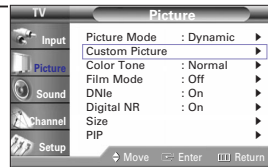

3 Press the ▲ or ▼ button to select the item you want to change.

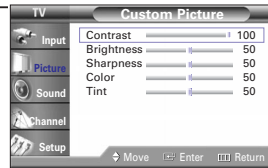

4 Press the ◀ or ▶ button to raise or lower the value of the item, using the on screen gauge as your guide.



When you are finished adjusting an item, wait a moment. The level indicator will disappear and the Video menu will return. You can continue to make adjustments, or press the EXIT button to exit.

NOTE

- Tint doesn't operate in PC, DVI or 480p-Component or higher modes.

Using Automatic ("Standard") Picture Settings

1 Press the P.MODE button on the remote control to change the picture settings.



2 Press P.MODE repeatedly to select the "Dynamic", "Standard", "Movie" or "Custom" picture setting.

Guide to Automatic Picture Settings

- Choose Standard to set the TV to operate at top performance according to your TV's specifications.
- Choose Dynamic for viewing the TV during the day or when there is bright light in the room.
- Choose Movie when viewing the movie.
- Choose Custom if you want to adjust the settings yourself.

Operation

Sound Control

You can control and customize the sound levels and settings of the TV with the remote control. Using the on-screen menus, you can change the TV's bass, treble, and balance settings.



Adjusting the Volume

Press VOL+ to raise the volume or VOL- to lower the volume.

Using the Mute Button

Press the MUTE button on the remote control to silence the volume. The word "Mute" will appear in the lower left corner of the screen.

To turn mute off, press the MUTE button again, or raise or lower the volume with the VOL - and VOL + buttons.



Customizing the Sound

1 Press the MENU button. Press the ▲ or ▼ button to select "Sound", then press the ENTER button.

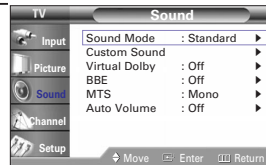

2 Press the ▲ or ▼ button to select "Custom Sound", then press the ENTER button. You will see the items "Bass", "Treble" or "Balance L/R".

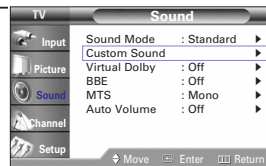

Continued...

3 Press the ▲ or ▼ button to select the item you want to change.

4 Press the ◀ or ▶ button to raise or lower the value of the item, using the on screen gauge as your guide.

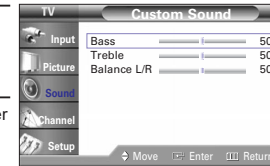

You can continue to make adjustments, or press the EXIT button to exit.

Using Automatic(Standard) Sound Settings

1 Press the S.MODE button on the remote control to change the automatic sound setting.



2 Press the S.MODE button again to select the "Standard", "Music", "Movie", "Speech" or "Custom" sound setting.

Guide to Automatic Sound Settings



- Choose Standard for the "factory" settings (the best choice for most people).
- Choose Music when watching music videos or concerts.
- Choose Movie when watching a movie.
- Choose Speech when watching a show that is mostly dialogue, like a news show.
- Choose Custom if you want to adjust the settings yourself.

Operation

Setting the Clock

This TV has a built-in clock that will appear on screen when you press the INFO button on the remote control. Setting this clock also allows you to use it to automatically turn the TV on or off.

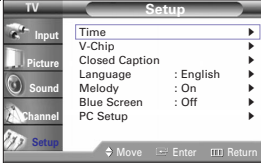

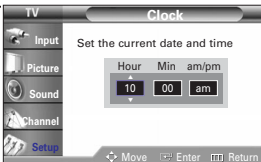
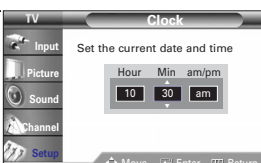
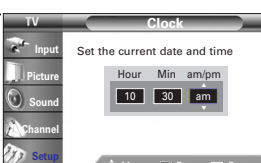
- 1 Press the MENU button. Press the ▲ or ▼ button to select "Setup", then press the ENTER button.

- 2 Press the ENTER button twice.

- 3 Press the ▲ or ▼ button to select the correct hour.

- 4 Press the ► button to select "Min", then press the ▲ or ▼ button to select the correct minute.

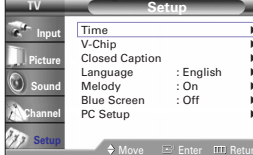
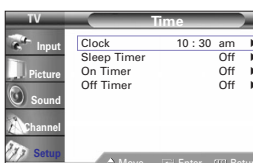
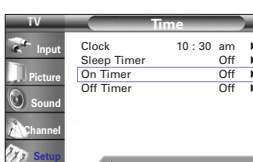
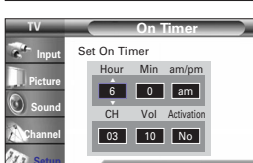
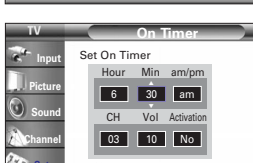
- 5 Press the ► button to select "am/pm", then press the ▲ or ▼ button to select the proper time of day (am or pm). Press the EXIT button to exit the menu.

Setting the Timers

This TV can be set to turn on or off automatically at specific times that you choose. Before using the timers, you must set the TV's clock, as described previously.

Setting the On/Off Timer

- 1 Press the MENU button. Press the ▲ or ▼ button to select "Setup", then press the ENTER button.

- 2 Press the ENTER button to select "Time".

- 3 Press the ▲ or ▼ button to select "On Timer", then press the ENTER button.

- 4 Press the ▲ or ▼ button to select the correct hour.

- 5 Press the ► button to select "Min", then press the ▲ or ▼ button to select the correct minute.

Continued...

Operation

- 6 Press the ► button to select "am/pm", then press the ▲ or ▼ button to select the proper time of day (am or pm).



- 7 Press the ► button to select "CH", then press the ▲ or ▼ button to select the channel you want when the TV turns on.



- 8 Press the ► button to select "Vol", then press the ▲ or ▼ button to select the volume level you want when the TV turns on.



- 9 Press the ► button to select "Activation", then press the ▲ or ▼ button to select "Yes". When On/Off timers are set, the "Timer" LED will illuminate (front or side panel of TV.)



- 10 When you are finished, press the MENU button twice.

- 11 If you want to set the Off Timer, press the ▲ or ▼ button to select "Off Timer". Set the "Off Timer" just as you set the "On Timer". Press the EXIT button to exit the menu.

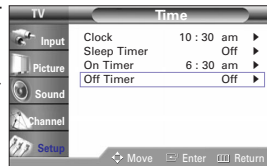

Absent Power Off

When you set the timer "On", your television will eventually be turned off, if you do not operate any controls during the 3 hours after the TV is turned on by timer. This function is available in only the timer "On" mode and will prevent a leakage accident or overheating, caused by your TV left on for a long time due to the timer "On" (when you are away on holiday, for example).

Setting the Sleep Timer

You can set your TV to automatically turn off after a preset interval.

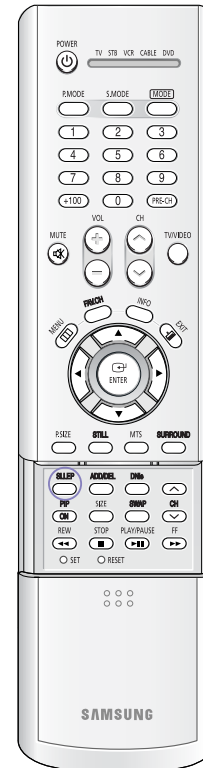

- 1 Press the SLEEP button on the remote control.



- 2 You'll see "Off" at the bottom of the screen. Press the Sleep button to select the time interval for the TV to stay on. The interval ranges from 30 to 180 minutes.

NOTE

- If no signal is received for 15 minutes, the TV will be automatically turned off.

Operation

Viewing an External Signal Source

Selecting the Signal Source

Use the remote control to switch between viewing signals from connected equipment, such as VCRs, DVD, Set-Top box and the TV source (broadcast or cable).



- 1 Make sure that the remote control is controlling the TV set. Press the MODE button and make sure that the "TV" LED is illuminated.

- 2 Press the MENU button. Press the ENTER button to select "Input".

- 3 Press the ENTER button to select "Source List".

- 4 Press the ▲ or ▼ button to select a particular signal source, then press the ENTER button to activate it. Press the EXIT button to exit the menu.



When you connect equipment to the TV, you can choose between the following sets of jacks: Video1, Video2, S-Video1, S-Video2, Component1, Component2, Component3, DVI or PC on the TV's rear panel, and Video3 or S-Video3 on the TV's side panel.

Assigning Names to External Input Mode

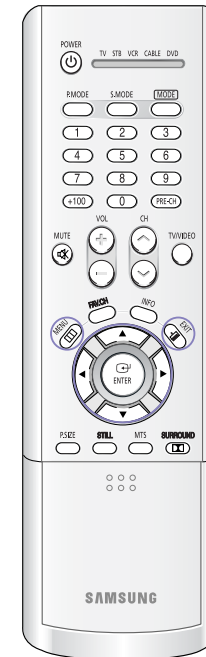

- 1 Press the MENU button. Press the ENTER button to select "Input".

- 2 Press the ▲ or ▼ button to select "Edit Name", then press the ENTER button.

- 3 Press the ENTER button to select "Video1". Press the ▲ or ▼ button to select external device: VCR, DVD, Cable STB, HD STB, Satellite STB, AV Receiver, DVD Receiver, Game, Camcorder, Combo or PC.

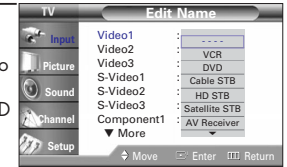

Set other signal sources using the same method as listed above. Press the EXIT button to exit the menu.

Operation

Remote Control VCR/DVD Buttons

Flip the cover of the remote control up to access buttons that can control the tape functions of a connected VCR or DVD, including Rewind, Play, Fast Forward, Stop and Pause.



- 1 Slide the cover of your remote control unit for access to the tape function controls. Press the appropriate buttons to control your VCR or DVD.

Special Features

Special Features

Setting Up Your Remote Control

This TV's remote control can operate almost any STB(Set-Top Box), VCR, cable box, or DVD. After it has been set up properly, your remote control can operate in five different modes: TV, STB(Set-Top Box), VCR, Cable, or DVD. Pressing the corresponding button on the remote control allows you to switch between these modes, and control whichever piece of equipment you choose.

Note

The remote control might not be compatible with all DVD Players, VCRs and Cable boxes.



Setting Up the Remote to Operate Your VCR

- 1 Turn off your VCR.
- 2 Press the MODE button and make sure that the VCR LED is illuminated. The remote control has five "modes": "TV", "STB", "VCR", "CABLE" and "DVD".
- 3 On your Samsung remote control, press the SET button.
- 4 Enter 3 digits of the VCR code listed on the next page for your brand of VCR. Make sure you enter 3 digits of the code, even if the first digit is a "0". If more than one code listed, try the first one. If your VCR does not turn on, repeat steps 2, 3, and 4, but try one of the other codes listed for the brand of your particular VCR.
- 5 Press the POWER button on the remote control. Your VCR should turn on. If your VCR turns on, your remote control is now set correctly.
- 6 Once your remote control is set up, press the MODE button any time you want to use the remote to operate your VCR.

Note on Using Remote Control Modes: VCR

- When your remote control is in "VCR" mode, the volume buttons still control your TV's volume.

Setting Up the Remote to Operate Your Cable Box

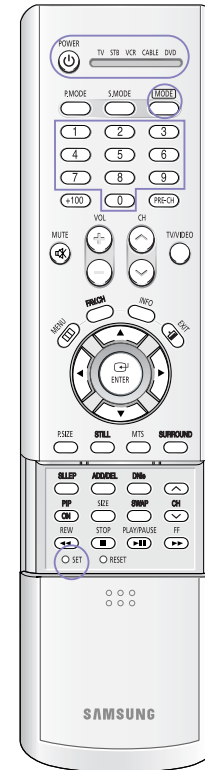

- 1 Turn off your cable box.
- 2 Press the MODE button and make sure that the CABLE LED is illuminated. The remote control has five "modes": "TV", "STB", "VCR", "CABLE" and "DVD".
- 3 On your Samsung remote control, press the SET button.
- 4 Enter 3 digits of the cable box code listed below for your brand of cable box. Make sure you enter 3 digits of the code, even if the first digit is a "0". (If more than one code listed, try the first one.) If your cable box does not turn on, repeat steps 2, 3, and 4, but try one of the other codes listed for your particular brand of cable box.
- 5 Press the POWER button. Your cable box should turn on. If your cable box turns on, your remote control is now "set up" correctly.
- 6 Once your remote control is set up, press the MODE button any time you want to use the remote to operate your cable box.

Note on Using Remote Control Modes: Cable Box

- When your remote control is in "Cable Box" mode, the volume buttons still control your TV's volume.

Special Features

Fine Tuning Channels

Fine tuning lets you manually adjust the TV's tuner if you have difficulty tuning in a channel.

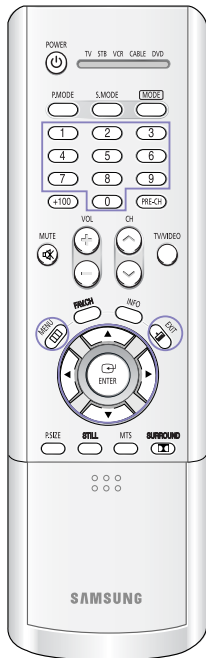

1 Using the number buttons on the remote control, select the channel you want to fine tune.

2 Press the MENU button. Press the ▲ or ▼ button to select "Channel", then press the ENTER button.

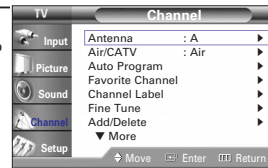

3 Press the ▲ or ▼ button to select "Fine Tune", then press the ENTER button.

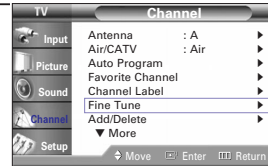

4 Press the ◀ or ▶ button to adjust the fine tuning.

To store the fine tuning setting in the TV's memory, press the ENTER button. (A * icon will appear.)



To reset the fine tuning to "0", press the ENTER button once more. Press the EXIT button to exit the menu.

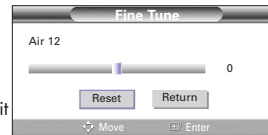

LNA (Low Noise Amplifier)

If the TV is operating in a weak-signal area, sometimes the LNA function can improve the reception (a low-noise preamplifier boosts the incoming signal).



1 Press the MENU button. Press the ▲ or ▼ button to select "Channel", then press the ENTER button.

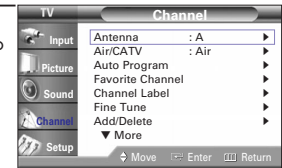

2 Press the ▲ or ▼ button to select "LNA", then press the ENTER button.



3 Press the ▲ or ▼ button to select "On" or "Off", then press the ENTER button. Press the EXIT button to exit the menu.



NOTE

- This function works in ANT-A mode only (not available in ANT-B mode).

Special Features

Selecting the Color Tone



1 Press the MENU button.
Press the ▲ or ▼ button to select "Picture", then press the ENTER button.

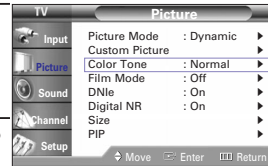

2 Press the ▲ or ▼ button to select "Color Tone", then press the ENTER button.

3 Press the ▲ or ▼ button to select "Cool2", "Cool1", "Normal", "Warm1" or "Warm2", then press the ENTER button. Press the EXIT button to exit the menu.

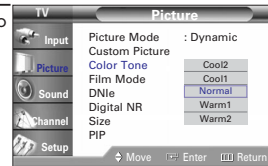

Setting the Film Mode

On: Automatically senses and processes film signals from all sources and adjusts the picture for optimum quality.

Off: Switches off the Film mode.

1 Press the MENU button.
Press the ▲ or ▼ button to select "Picture", then press the ENTER button.

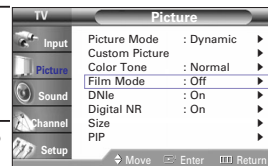

2 Press the ▲ or ▼ button to select "Film Mode", then press the ENTER button.

3 Press the ▲ or ▼ button to select "On" or "Off", then press the ENTER button. Press the EXIT button to exit the menu.

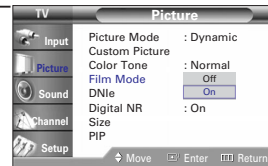

NOTE

- Film mode is supported in 480i only.

DNLe™ (Digital Natural Image engine) **DNLe™**

Samsung's New Technology enables an improved image with detail, contrast and white enhancement and 3D noise reduction.

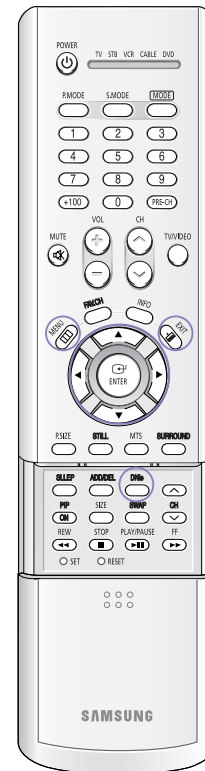

1 Press the MENU button.
Press the ▲ or ▼ button to select "Picture", then press the ENTER button.

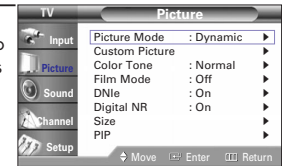

2 Press the ▲ or ▼ button to select "DNLe", then press the ENTER button.

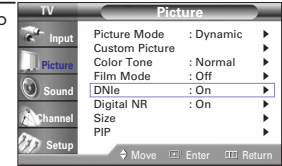

3 Press the ▲ or ▼ button to select "Off", "Demo" or "On", then press the ENTER button. Press the EXIT button to exit the menu.

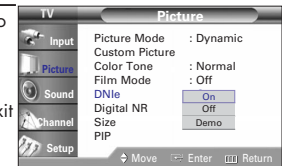

Guide to DNLe Settings

- On: Switches on the DNLe mode.
- Demo: The screen before applying DNLe appears on the right and the screen after applying DNLe appears on the left.

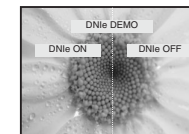

- Off: Switches off the DNLe mode.

Special Features

Digital Noise Reduction

If the broadcast signal received by your TV is weak, you can activate the Digital Noise Reduction feature to help reduce any static and ghosting that may appear on the screen.



- 1 Press the MENU button.
Press the ▲ or ▼ button to select "Picture", then press the ENTER button.

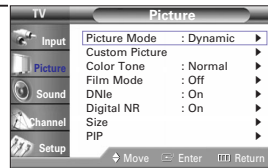

- 2 Press the ▲ or ▼ button to select "Digital NR", then press the ENTER button.

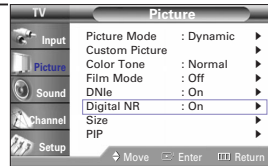

- 3 Press the ▲ or ▼ button to select "On" or "Off", then press the ENTER button. Press the EXIT button to exit the menu.

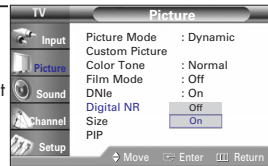

Setting the Blue Screen Mode

If no signal is being received or the signal is very weak, a blue screen automatically replaces the noisy picture background. If you wish to continue viewing the poor picture, you must set the "Blue Screen" mode to "Off".



- 1 Press the MENU button.
Press the ▲ or ▼ button to select "Setup", then press the ENTER button.

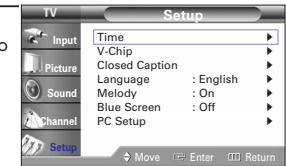

- 2 Press the ▲ or ▼ button to select "Blue Screen", then press the ENTER button.

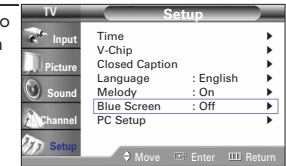

- 3 Press the ▲ or ▼ button to select "On" or "Off", then press the ENTER button. Press the EXIT button to exit the menu.

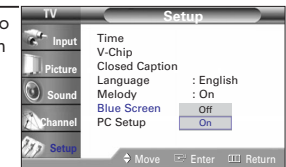

Special Features

Changing the Screen Size

When you press the P.SIZE button on the remote control, the TV's screen mode choices appear in sequence. The screen displays in this order: Wide, Panorama, Zoom1, Zoom2, 4:3. The name of the screen mode will be displayed at the bottom of the TV screen.



Wide

Sets the picture to 16:9 wide mode.

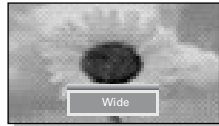

Panorama

Use this mode for the wide aspect ratio of a panoramic picture.

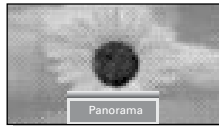

Zoom1

Magnifies the size of the picture on screen. You can also move the picture on screen using the scroll function. Press the ▲ or ▼ button to scroll the picture.

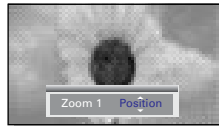

Zoom2

Magnifies the size of the picture more than Zoom1. You can also move the picture on screen using the scroll function. Press the ▲ or ▼ button to scroll the picture.

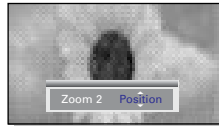

4:3

Sets the picture to 4:3 normal mode. This is a standard TV screen size.

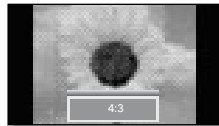

NOTES

- You can select only Wide, 4:3 screen size in the Component(480p, 720p, 1080i) Mode.
- With PIP On, the screen automatically becomes wide in the Antenna, Video (1~3), S-Video (1~3) or Component (480i) mode. With PIP Off, it returns to original screen size.

Special Audio Options

MTS Settings: Choosing a Soundtrack

Depending on the particular program being broadcast, you can listen to stereo, mono, or a Separate Audio Program. (SAP audio is usually a foreign-language translation. Sometimes SAP has unrelated information like news or weather.)



- Press the MENU button. Press the ▲ or ▼ button to select "Sound", then press the ENTER button.

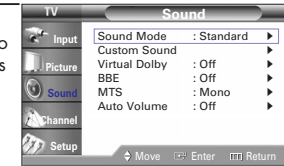

- Press the ▲ or ▼ button to select "MTS", then press the ENTER button.

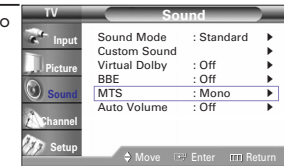

- Press the ▲ or ▼ button to select "Mono", "Stereo" or "SAP", then press the ENTER button. Press the EXIT button to exit the menu.

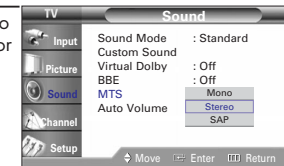

Guide to MTS Settings

- Choose Stereo for channels that are broadcasting in stereo.
- Choose Mono for channels that are broadcasting in mono, or if you are having difficulty receiving a stereo signal.
- Choose SAP to listen to the Separate Audio Program, which is usually a foreign-language translation.

Special Features

Virtual Dolby

This feature allows the TV's L/R speakers to provide a home Theater-like Dolby effect. The center and surround sounds are mixed into the L/R speakers.

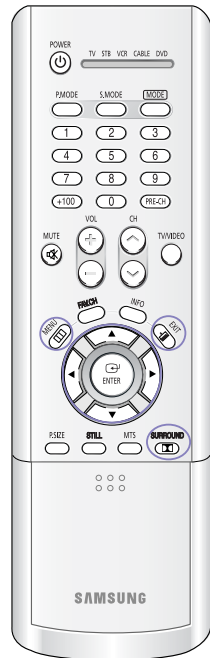

Quick way to access Virtual Dolby: Just press the SURROUND button on the remote control.

1 Press the MENU button. Press the ▲ or ▼ button to select "Sound", then press the ENTER button.

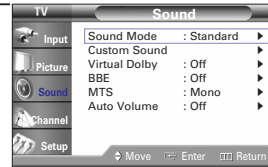

2 Press the ▲ or ▼ button to select "Virtual Dolby", then press the ENTER button.

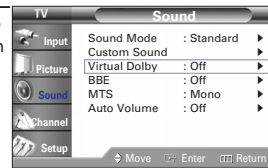

3 Press the ▲ or ▼ button to select "Off" or "On", then press the ENTER button. Press the EXIT button to exit the menu.

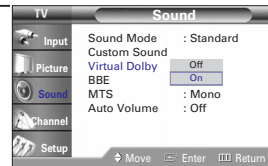

NOTE

- Virtual Dolby and BBE can't be set ON at the same time.

BBE

BBE is a built-in effect that adds clarity, punch and dynamics to the sound.

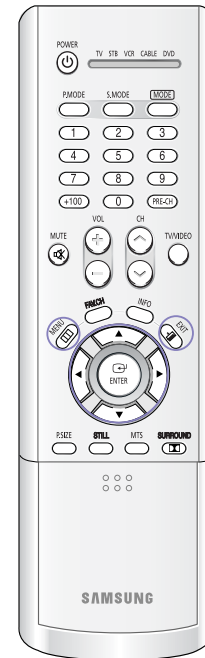

1 Press the MENU button. Press the ▲ or ▼ button to select "Sound", then press the ENTER button.

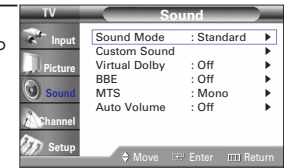

2 Press the ▲ or ▼ button to select "BBE", then press the ENTER button.

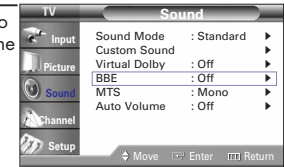

3 Press the ▲ or ▼ button to select "Off" or "On", then press the ENTER button. Press the EXIT button to exit the menu.

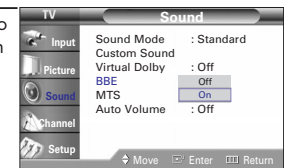

NOTE

- Virtual Dolby and BBE can't be set ON at the same time.

Special Features

Auto Volume

Each broadcasting station has its own signal conditions, and it is inconvenient to adjust the volume every time the channel is changed. "Auto Volume" automatically adjusts the volume of the desired channel by lowering the sound output when the modulation signal is high or by raising the sound output when the modulation signal is low.



- 1 Press the MENU button. Press the ▲ or ▼ button to select "Sound", then press the ENTER button.

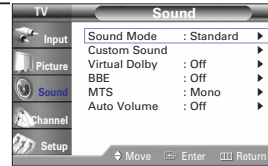

- 2 Press the ▲ or ▼ button to select "Auto Volume", then press the ENTER button.

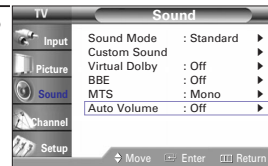

- 3 Press the ▲ or ▼ button to select "Off" or "On", then press the ENTER button. Press the EXIT button to exit the menu.

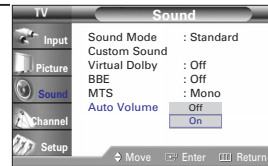

Setting The On/Off Melody

A melody sound can be set to come on when the TV is powered On or Off.



- 1 Press the MENU button. Press the ▲ or ▼ button to select "Setup", then press the ENTER button.

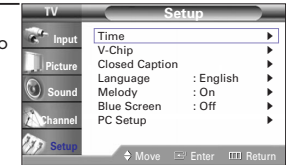

- 2 Press the ▲ or ▼ button to select "Melody", then press the ENTER button.

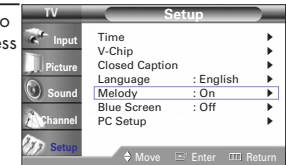

- 3 Press the ▲ or ▼ button to select "On", then press the ENTER button. Press the EXIT button to exit the menu.

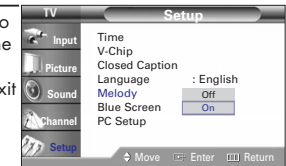

Special Features

Viewing Closed Caption Information

Your TV decodes and displays the closed captions information that is broadcast along with some television shows. These captions are usually subtitles for the hearing impaired or translations into other languages. All VCRs record the closed caption signal from television programs, so pre-recorded video tapes can also deliver closed-caption information. Check for the closed caption symbol (CC) on the tape's package or your TV program-schedule.

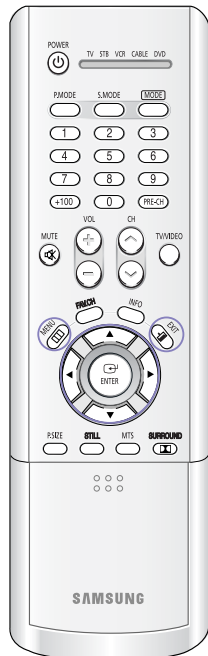

Closed Captions

- 1 Press the MENU button. Press the ▲ or ▼ button to select "Setup", then press the ENTER button.

Press the ▲ or ▼ button to select "Closed Caption", then press the ENTER button.
- 2 Press the ENTER button to select "Closed Caption". Press the ▲ or ▼ button to select "On", then press the ENTER button.
- 3 Press the ▲ or ▼ button to select "Caption Mode", then press the ENTER button.
- 4 Press the ▲ or ▼ button to select caption mode you want, then press the ENTER button. Press the EXIT button to exit the menu.

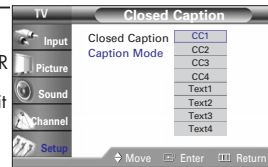
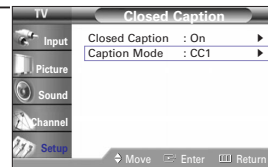
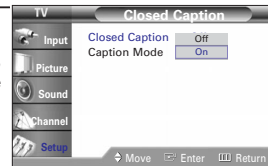
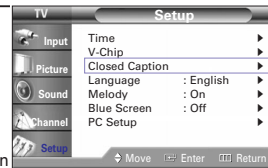

Guide to Caption Mode

- CC1~CC4: In caption mode, caption appears at the bottom of the screen, and they usually cover only a small portion of the picture.
- Text1~Text4: In text mode, information unrelated to the program, such as news or weather, is displayed. Text often covers a large portion of the screen.

NOTE

- The Caption function doesn't operate when the PIP is active.

Viewing Picture-in-Picture

One of the most best features of your TV is the Picture-in-Picture (PIP) feature. The advanced PIP screen allows you to watch two different pictures at once, even if you don't have a VCR connected to your TV.

Selecting a PIP Screen

Quick way to access PIP: Just press the PIP button on the remote control.

- 1 Press the MENU button. Press the ▲ or ▼ button to select "Picture", then press the ENTER button.
- 2 Press the ▲ or ▼ button to select "PIP", then press the ENTER button twice.
- 3 Press the ▲ or ▼ button to select "On", then press the ENTER button. The PIP image will appear in the corner of the screen. Press the EXIT button to exit the menu.

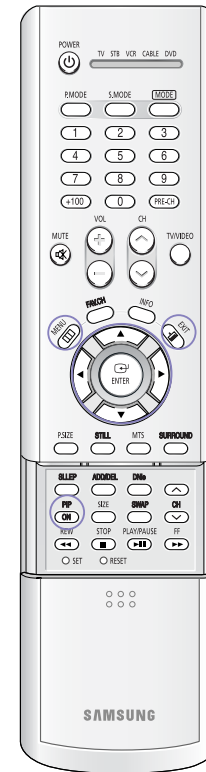
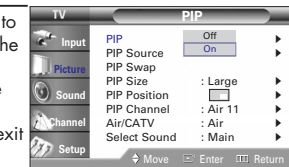
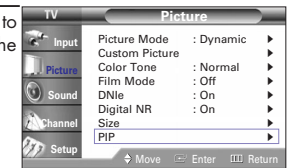
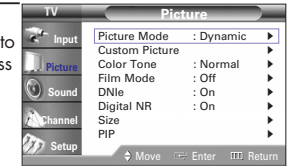

NOTES

- Picture-in-Picture doesn't function when the V-chip or Caption is active.
- If you turn the TV off while watching and turn it on again, then the mode will return to normal video.
- Screen size can't be changed when the PIP is active in the TV, Video or Component(480i) mode.

Special Features

Selecting an External Signal

You can use PIP to view a signal from an external source, such as a VCR.



- 1 Press the MENU button. Press the ▲ or ▼ button to select "Picture", then press the ENTER button.

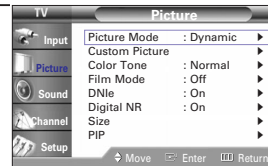

- 2 Press the ▲ or ▼ button to select "PIP", then press the ENTER button.

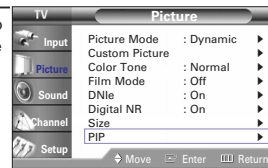

- 3 Press the ▲ or ▼ button to select "PIP Source", then press the ENTER button.

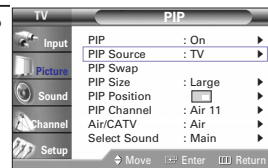

The signal from these inputs will not appear if you have not connected any equipment to the TV's input jacks.

For more information about external signals, see "Viewing an External Signal Source" (See page 46). If you select "TV" the PIP image is the same as the main image.

- 4 Press the ▲ or ▼ button to select an external signal then press the ENTER button.

You can choose between "TV", "Video1~3" or "S-Video1~3". Press the EXIT button to exit the menu.

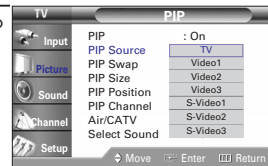

NOTE

- The PIP subscreen doesn't support ANT-B, Component1, Component2, Component3, PC, and DVI.

Selecting a Signal Source (Antenna or Cable) for PIP

If the PIP source is TV during PIP ON, you can select the broadcasting source of PIP picture separately from the main picture. (If the main picture is ANT-B and the broadcasting sources are different, making adjustments is necessary.)

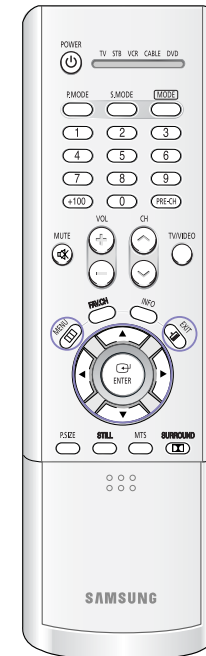

- 1 Press the MENU button. Press the ▲ or ▼ button to select "Picture", then press the ENTER button.

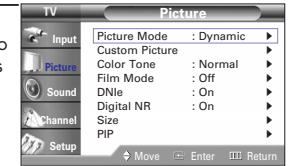

- 2 Press the ▲ or ▼ button to select "PIP", then press the ENTER button.

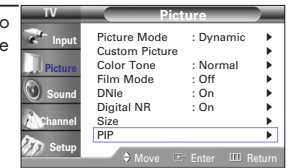

- 3 Press the ▲ or ▼ button to select "Air/CATV", then press the ENTER button.

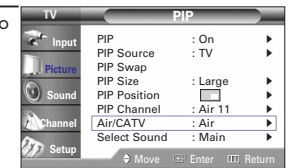

- 4 If an antenna is connected, the setting is "Air".

If a Cable TV system is providing the signal, press the ▲ or ▼ button until the appropriate type of cable system is displayed ("STD", "HRC" or "IRC").

Press the EXIT button to exit the menu.

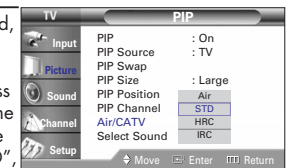

Special Features

Swapping the Contents of the PIP and Main image

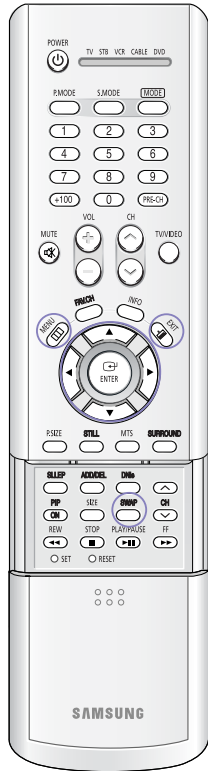

Quick way to access PIP size: Just press the **SIZE** button on the remote control.

- 1 Press the **MENU** button. Press the **▲** or **▼** button to select "Picture", then press the **ENTER** button.

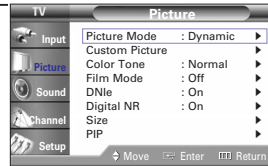

- 2 Press the **▲** or **▼** button to select "PIP", then press the **ENTER** button.

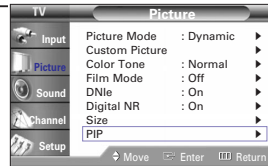

- 3 Press the **▲** or **▼** button to select "PIP Swap", then press the **ENTER** button. The PIP image will appear in the main image, and vice versa. Press the **EXIT** button to exit the menu.

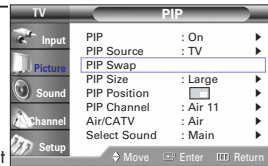

NOTE

- When ANT/B, Component mode, PC, or DVI is selected, the PIP Swap function doesn't work.

Changing the Size of the PIP image

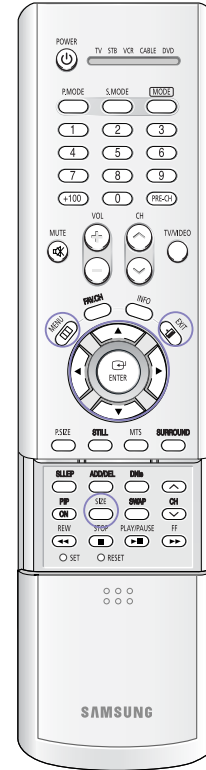

- 1 Press the **MENU** button. Press the **▲** or **▼** button to select "Picture", then press the **ENTER** button.

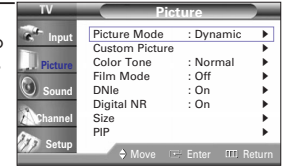

- 2 Press the **▲** or **▼** button to select "PIP", then press the **ENTER** button.

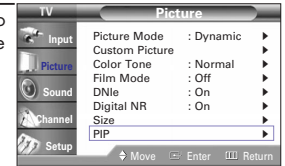

- 3 Press the **▲** or **▼** button to select "PIP Size", then press the **ENTER** button.

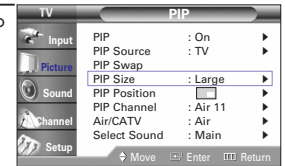

- 4 Press the **▲** or **▼** button to select "Small", "Large", "Double1" or "Double2", then press the **ENTER** button. Press the **EXIT** button to exit the menu.

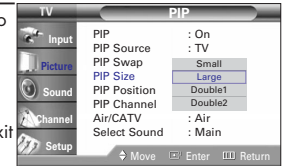

NOTE

- Double function doesn't operate in the PC and DVI mode.

Special Features

- 5 You can independently lock the TV ratings. The locked TV (FCC) ratings are indicated by the symbol (🔒). Press the ▲/▼/◀/▶ buttons and the ENTER button to activate the appropriate restrictions for TV (FCC) rating system.

TV-Y	Young children
TV-Y7	Children 7 and over
TV-G	General audience
TV-PG	Parent Guidance
TV-14	Viewers 14 and over
TV-MA	Mature Audience.

Press the EXIT button to exit the menu.

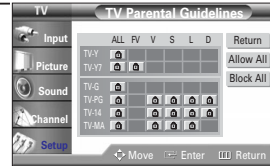

NOTE

- These categories consist of two separate groups: TV-Y and TV-Y7 (young children through age 7), and TV-G through TV-MA (everybody else). The restrictions for these two groups work independently: If a household includes very young children as well as young adults, the TV guidelines must be set up separately for each age group. (See next step.)

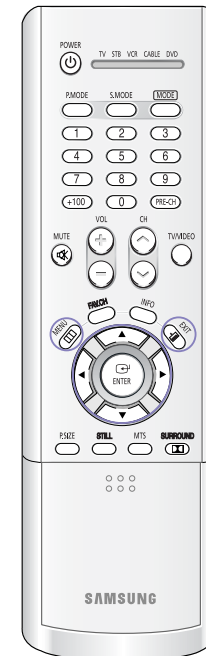

How to Set up Restrictions using the Movie Ratings: G, PG, PG-13, R, NC-17, X

The Movie rating system uses the Motion Picture Association of America (MPAA) system, and its main application is for movies. When the Rating Controls is on, the TV will automatically block any programs that are coded with objectionable ratings (either Movie Ratings or TV Parental Guidelines).

- 1 Press the MENU button. Press the ▲ or ▼ button to select "Setup", then press the ENTER button.

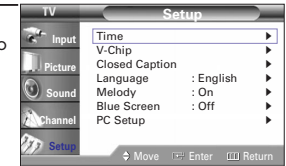

- 2 Press the ▲ or ▼ button to select "V-Chip", then press the ENTER button.

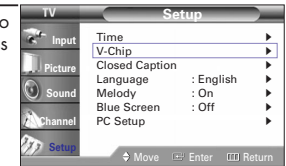

- 3 Press the ENTER button. Press the number button to enter current PIN your 4-digit PIN number.

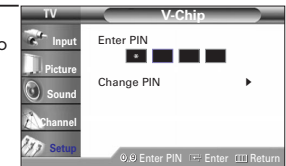

- 4 Press the ▲ or ▼ button to select "Movie Ratings", then press the ENTER button.



- 5 You can independently lock the Movie ratings. The locked Movie ratings are indicated by the symbol (🔒). Press the ▲/▼/◀/▶ buttons and the ENTER button to activate the appropriate restrictions for Movie rating system. Press the EXIT button to exit the menu.

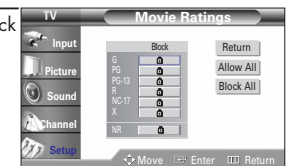

Special Features

Important Notes About Parental Locks

Explanation of the MPAA and TV (FCC) Rating Systems:

TV (FCC) Age-Based Ratings

TV-MA

Mature audiences only. This program may contain mature themes, profane language, graphic violence and explicit sexual content.

TV-14

Parents strongly cautioned. This program may contain sophisticated themes, sexual content, strong language and more intense violence.

TV-PG

Parental guidance suggested. The program may contain infrequent coarse language, limited violence, some suggestive sexual dialogue and situations.

TV-G

General audience. It contains little or no violence, no strong language, and little or no sexual dialogue or situations.

TV-Y7

Directed to older children. Themes and elements in this program may include mild physical or comedic violence, or may frighten children under the age of seven.

TV-Y

All children. The themes and elements in this program are specifically designed for a very young audience, including children from ages two – six.

TV (FCC) Content Category

V	Violence.
S	Sexual content.
L	Offensive language.
D	Dialogue sexual innuendo.
FV	Fantasy or cartoon violence.

MPAA Rating System (Movies)

G	General audience. No restriction.
PG	Children under 13 should be accompanied by an adult.
PG-13	Parental guidance suggested. Children under 13 should be accompanied by an adult.
R	Restricted. Viewers should be 17 or older.
NC-17	Not classified. Viewers should be 17 or older.
X	Adults only.

- TV (FCC) ratings: The particular rating that you have selected will be locked (and indicated as a red "L" on a blue background). Also, all of the age-based ratings will be locked within the particular group (i.e., "group 1" or "group 2"). Suppose that the TV-G rating and all of its contents (V, S, L, and D) are locked. In that case, more restrictive ratings (TV-PG, TV-14, and TV-MA) and all of their contents (V, S, L, and D) are automatically locked as well.
- MPAA ratings: The particular rating that you have selected will be locked. In addition, more restrictive ratings will be locked as well.
- Neither TV (FCC) ratings nor MPAA ratings apply to news programs.

PC Display

PC Display

Using Your TV as a Computer (PC) Display

How to connect Your PC to the TV

Note: This figure shows the Standard Connector-jack panel. The actual configuration on your TV may be different, depending on the model.

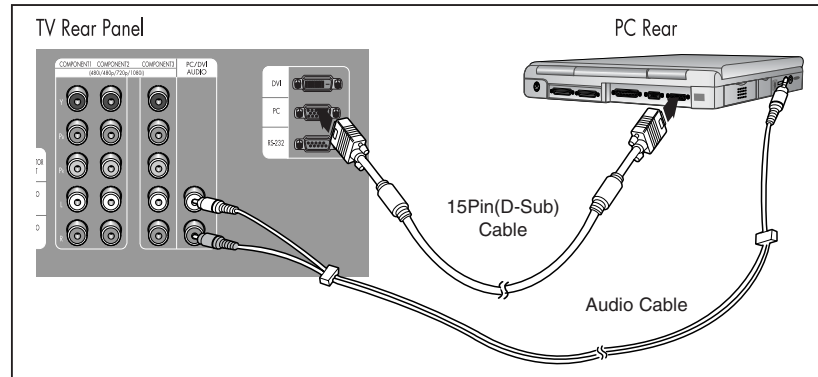

NOTE

The RS232 jack is for repairs and software upgrades.

How to Set up Your PC Software (Windows only)

The Windows display-settings for a typical computer are shown below. The actual screens on your PC will probably be different, depending upon your particular version of Windows and your particular video card. However, even if your actual screens look different, the same basic setup information will apply in almost all cases. (If not, contact your computer manufacturer or Samsung Dealer.)

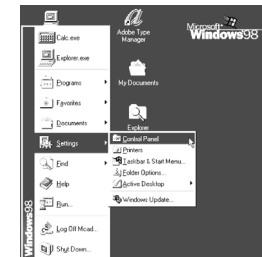

First, click on "Settings" on the Windows start menu.

While "Settings" is highlighted, move the cursor so that "control panel" is highlighted.

When the control panel screen appears, click on "Display" and a display dialog-box will appear.

Navigate to the "Settings" tab on the display dialog-box.

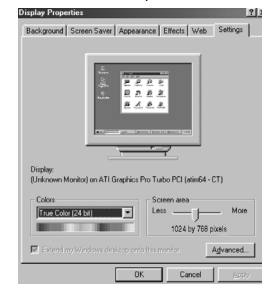

The two key variables that apply to the TV-PC interface are "resolution" and "colors". The correct settings for these two variables are:

- * Screen area (sometimes called "resolution"): 1024 x 768 pixels
- * Color: "24-bit" color (might also be expressed as "16 million colors"). Shown at left is a typical screen for "Display" dialog box.

If a vertical-frequency option exists on your display settings dialog box, the correct value is "60" or "60 Hz". Otherwise, just click "OK" and exit the dialog box.

continued...

PC Display

Display Modes

Mode	Resolution	Horizontal Frequency [KHz]	Vertical Frequency [Hz]	Pixel Clock [MHz]	Sync Polarity (H/V)
VGA	640 x 350	31.47	70.00	25.175	+/-
		31.47	70.00	28.322	-/-
	720 x 400	37.93	85.00	35.5	-/+
		31.47	60.00	25.175	-/+
		35.00	66.70	30.24	-/-
		37.86	72.80	31.50	-/-
		37.50	75.00	31.50	-/-
43.27	85.00	36.00	-/-		
SVGA	800 x 600	35.16	56.30	36.00	+/-
		37.88	60.30	40.00	+/-
		48.08	72.20	50.00	+/+
		46.87	75.00	49.50	+/+
		53.67	85.10	56.25	+/+
		49.73	74.60	57.284	-/+
	832 x 624	48.36	60.00	65.00	-/-
XGA	1024 x 768	56.40	70.10	75.00	-/-
		60.02	75.00	78.75	+/-
		60.02	75.00	78.75	+/-
DTV	1920 x 1080i	33.75	60	74.25	X
	1280 x 720p	45.00	60	74.25	X
	720 x 483p	31.47	60	27	X

NOTE

- Both screen position and size will vary, depending on the type of PC monitor and its resolution. The table above shows all of the display modes that are supported:
 - * The interlace mode is not supported.
 - * The TV will operate abnormally if a non-standard video format is selected.

NOTES

- When this TV is used as a PC display, 32-bit color is supported (over 16 million colors).
- Your PC display screen might appear different, depending on the manufacturer (and depending on your particular version of Windows). Check your PC instruction book for information about connecting your PC to a TV display-monitor.
- Same modes as PC are supported for the signal input to the DVI jack. Only a separate sync signal is supported.

How to Set up Your TV as a PC display

"Auto Adjust" allows the TV to self-adjust to the incoming video signal. The values of fine, coarse and position are adjusted automatically.



1 Press the TV/VIDEO button to select "PC".

2 Press the ▲ or ▼ button to select "Setup", then press the ENTER button.

3 Press the ▲ or ▼ button to select "PC Setup", then press the ENTER button.

4 Press the ▲ or ▼ button to select "Auto Adjustment", then press the ENTER button.

Press the EXIT button to exit the menu.

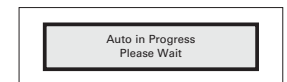
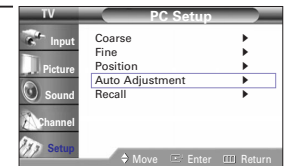
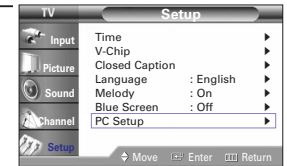
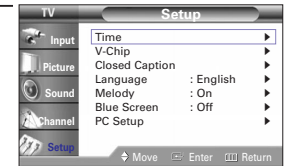

PC Display

Picture Quality Adjustment

The purpose of picture quality adjustment is to remove or reduce picture noise. If the noise is not removed by fine tuning alone, then do the frequency adjustments to the utmost and fine tune again. After the noise has been reduced, re-adjust the picture so that it is aligned on the center of screen.



Frequency Adjustment

- 1 Press the TV/VIDEO button to select "PC".
- 2 Press the ▲ or ▼ button to select "Setup", then press the ENTER button.
- 3 Press the ▲ or ▼ button to select "PC Setup", then press the ENTER button.
- 4 Press the ENTER button to select "Coarse", then press the ENTER button.
- 5 Remove picture noise (vertical stripes) on the screen by pressing the ◀ or ▶ button. (If frequency is not set properly, then vertical stripes will appear on the screen).

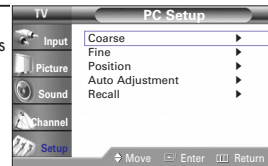
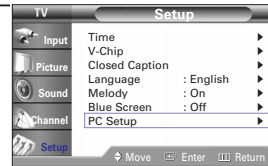
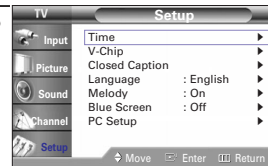

Fine tuning

- 6 Press the ▲ or ▼ button to select "Fine", then press the ENTER button.
- 7 Remove picture noise (vertical stripes) on the screen by pressing the ◀ or ▶ button. (If phase is not set properly, the picture may be blurry). Press the EXIT button to exit the menu.

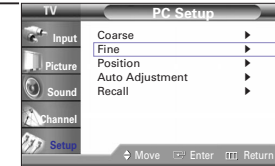

PC Display

Changing the Position of the Image (Moving left, right, up and down)

After connecting the TV to your PC, adjust the position of screen if it is not well-aligned.



1 Press the TV/VIDEO button to select "PC".

2 Press the ▲ or ▼ button to select "Setup", then press the ENTER button.

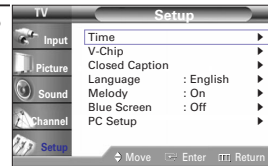

3 Press the ▲ or ▼ button to select "PC Setup", then press the ENTER button.

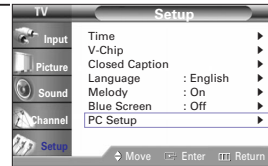

4 Press the ▲ or ▼ button to select "Position", then press the ENTER button.

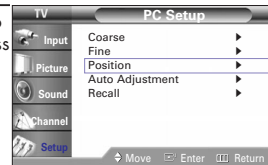

5 Adjust the position of screen by pressing the ▲/▼/◀/▶ button. Press the EXIT button to exit the menu.

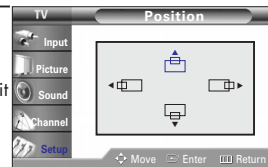

To Initialize the Screen Position and Picture Quality Adjustment

After steps 1~3 above are completed, press the ▼ button to select "Recall". Press the ENTER button to initialize the screen position and picture quality.

NOTE

- If a PC signal is input to DVI, you can't adjust the quality and position of picture.

PC Display

Changing the Screen Size (PC mode)

When you press the P.SIZE button on the remote control, the TV's screen mode choices appear in sequence. The screen displays in this order: Wide TV, Wide PC, Expand, 4:3. The name of the screen mode will be displayed at the bottom of the TV screen.



Wide TV

Scales the picture to the size of the TV screen regardless of the aspect ratio of the input source.

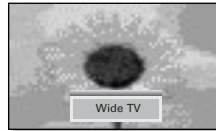

Wide PC

Scales the picture to 92% of the screen regardless of the aspect ratio of the input source.

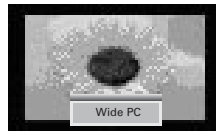

Expand

Scales the picture to the aspect ratio of the input source.

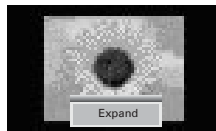

4:3

Displays the picture as it is without changing the aspect ratio of input source.

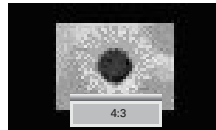

NOTE

- The Wide PC and Expand screen modes are recommended for the PC mode.

Aspect Supported settings

Source (PC/DVI)	Aspect
1920 x 1080i	Wide TV → 4:3
1280 x 720	Wide TV → Wide PC → Expand → 4:3
1024 x 768	Wide TV → Wide PC → Expand
720 x 483 (480p)	Wide TV → 4:3
Others	Wide TV → Wide PC → Expand → 4:3

NOTES

- In VGA (640x480) and SVGA (800x600) modes, the Wide and 4:3 screen modes are available.
- In XGA (1024x768) mode, the Wide screen mode is available.

Appendix

SAMSUNG

Appendix

Troubleshooting

Before you call a service technician, please scan this list of problems and possible solutions. It may save you time and money.

Problem	Possible Solution
Poor picture quality.	Try another channel. Adjust the antenna. Check all wire connections.
Poor sound quality or no sound.	Try another channel. Adjust the antenna. Make sure the "Mute" button is off.
No picture or sound.	Try another channel. Press the TV/Video button. Make sure the TV is plugged in. Check the antenna connections.
No color or wrong colors.	Make sure the program is broadcasted in color. Adjust the picture settings.
Picture rolls vertically.	Adjust the antenna. Check all wire connections. If you are using a VCR, check the tracking.
Erratic operation, or intermittent failure.	Unplug the TV for 30 seconds, then try again.
Remote control failure.	Press the MODE button to put your remote control into "TV" mode. Make sure the remote has batteries.
TV won't switch on.	Make sure the wall outlet is working. Make sure the remote has batteries.

- The display panel used for the DLP Projection TV is composed of many tiny pixels. These, pixels may occasionally appear on the screen.

Care and Maintenance

With proper care, your TV will give you many years of service. Please follow these guidelines to get the maximum performance from your TV.

Placement

- Do not put the TV near extremely hot, cold, humid or dusty places.
- Do not put the TV near appliances that create magnetic fields.
- Keep the ventilation openings clear.
- Place the TV on a flat and level surface.
(Raising one of it's corners may cause the picture to tilt.)

Liquids

- Do not handle liquids near or on the TV.

Cabinet

- Never open the cabinet or touch the parts inside.
- Wipe your TV with a clean, dry cloth. Never use water, cleaning fluids, wax, or chemicals.
- Do not put heavy objects on top of the cabinet.
- This DLP Projection TV projects the image onto a large screen by applying an optical system. If you place the TV set face down, it might cause a problem because dirt, or some other contaminant may become attached to the inside of the TV set.

Temperature

- If your TV is suddenly moved from a cold to a warm place, unplug the power cord for at least two hours so that moisture that may have formed inside the unit can dry completely.

Using the TV in Another Country

If you plan to take your TV to a foreign country, please be aware of the different television systems that are in use around the world. A TV designed for one system may not work properly with another system due to differences in the TV channel frequencies.

Specifications

Model	HLN4365W1/HLN437W1	HLN5065W1/HLN507W1	HLN617W1	HLN467W1	HLN567W1
Voltage	AC 120V	AC 120V	AC 120V	AC 120V	AC 120V
Frequency of Operation	60Hz	60Hz	60Hz	60Hz	60Hz
Power Consumption	200 watts	200 watts	200 watts	200 watts	200 watts
Dimension (W x D x H)	1029 x 399 x 755 mm 40.5 x 15.7 x 29.7 inches	1184 x 444 x 859 mm 46.6 x 17.5 x 33.8 inches	1436 x 489 x 1021mm 56.5 x 19.3 x 40.2 inches	1047 x 399 x 779 mm 41.2 x 15.7 x 30.6inches	1268 x 461 x 924mm 49.9 x 18.1 x 36.4 inches
Weight	30.5 Kg / 67.2 lbs	35.2 Kg / 77.6 lbs	46.2 Kg / 101.9 lbs	33.5 Kg / 73.8 lbs	41.5 Kg / 91.5lbs